



16

RASVETA

RASVETA

16.1 LED TRAKE	372
LYNX PREMIUM 12DC	374
LYNX BASIC 12DC	378
LYNX PREMIUM 24DC	380
NEONLYNX 24 DC	381
16.2 LED KONEKTORI	382
LED KONEKTORI 12DC	382
LED KONEKTORI 24DC	383
16.3 SENZORI I PREKIDAČI	384
LED SENZORI 12DC	384
LED SENZORI 12DC/24DC	385
LED SENZORI 240V AC	386
LED PREKIDAČI	388
16.4 TRANSFORMATORI	389
LED TRANSFORMATORI 12DC	389
LED TRANSFORMATORI 24DC	390
16.5 LED PROFILI I DIFUZORI	391
LED PROFILI UKOPAVAJUCI (ZAKRIVLJEN DIFUZOR)	391
LED PROFILI UKOPAVAJUCI (RAVAN DIFUZOR)	391
LED PROFILI NADGRADNI	391
LED PROFILI UGAONI	392
16.6 LED LAMPE	393



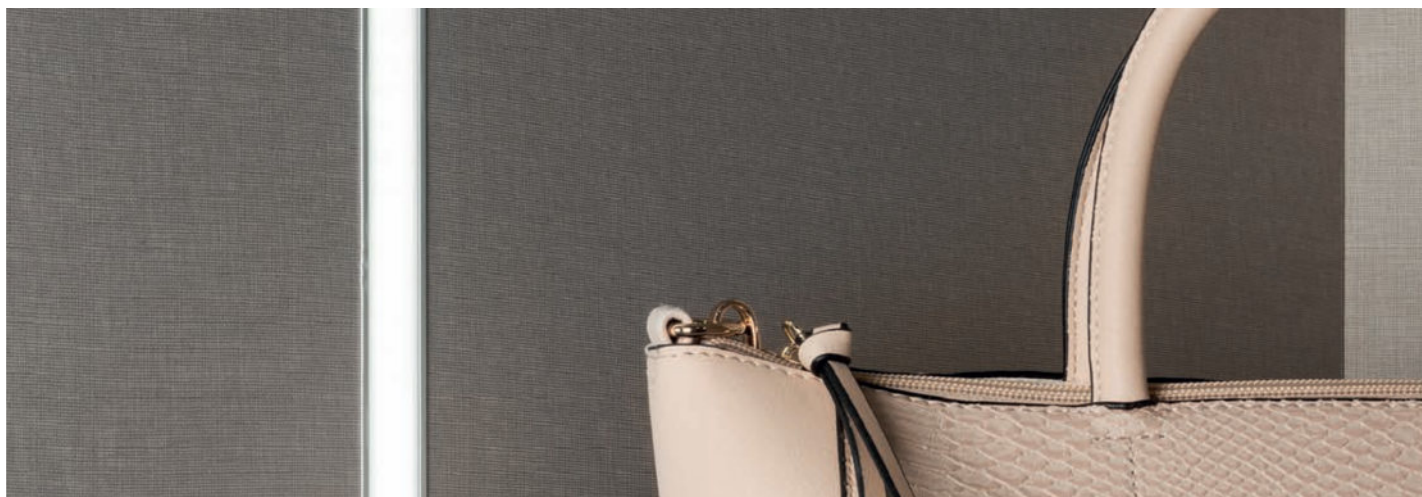





Lynx Premium

Led traku "Lynx Premium" karakterišu visoke performanse i dobra energetska efikasnost, i kao takva predstavlja idealno rešenje za komercijalne instalacije. IRC (Index reprodukcije boje) $Ra \geq 80$. Atest 50.000 sati. BIN (Devijacija boje) ± 150 Kelvina. Svetlosni fluks (efikasnost) 84 Lm/W. IP Silikon. Sastav led trake: bakar i zlato. Samolepljiva traka u koturima od 5 i 10 metara. Jačina trake 4,8W/m, 9,6W/m, 14,4W/m, 28,8W/m (hladno, toplo i prirodno bela), 14,4W/m (RGB traka) i 28,8W/m (T^a Var).







Lynx Premium
4,8W/m IP20



	Cod.		
	52009	20	2
	52010	20	1
	52011	20	2





Lynx Premium
9,6W/m IP20



	Cod.		
	52014	20	2
	52015	20	1
	52016	20	2

Lynx Premium
14,4W/m IP20



	Cod.		
	52019	20	2
	52020	20	2
	52021	20	2





Lynx Premium
28,8W/m IP20



	Cod.		
	52024	20	2





Lynx Premium CCT adjustable
28,8W/m IP65



	Cod.		
 	52026	20	1

Lynx Premium RGB
14,4W/m IP65



	Cod.		
  	50208	15	1

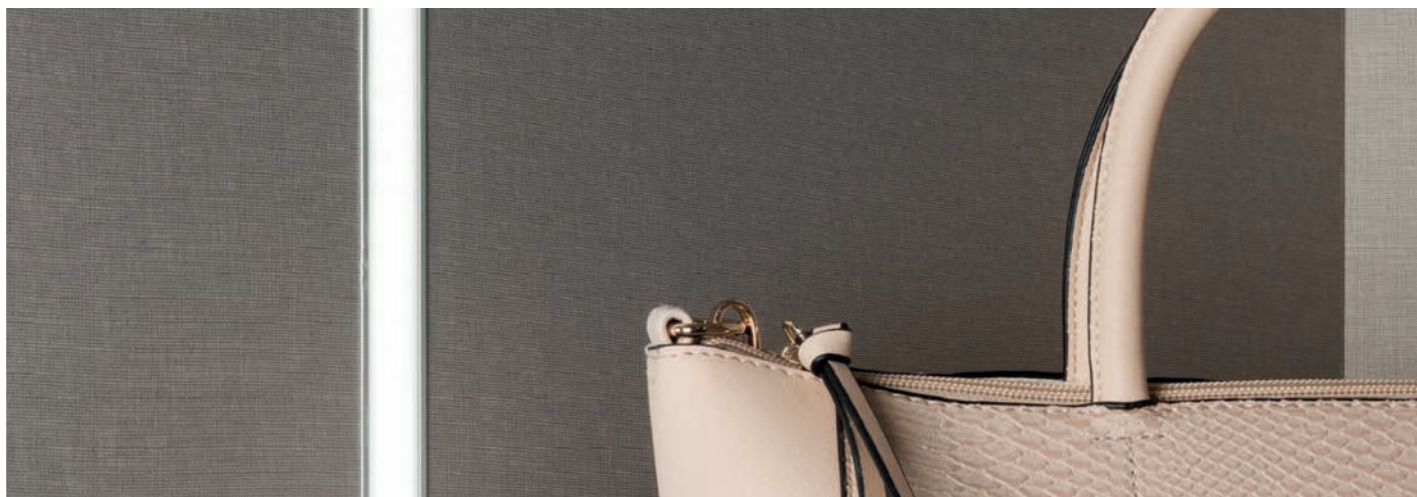

Lynx Basic

Led traku "Lynx Basic" karakteriše dobar nivo performansi. IRC (Index reprodukcije boje) $Ra \geq 70$. Atest 20.000 sati. BIN (Devijacija boje) ± 300 Kelvina. Svetlosni fluks (efikasnost) 69 Lm/W. IP PUR. Sastav led trake: bakar i metal. samolepljiva traka u koturovima od 5 metara. Jačina trake 4,8W/m i 9,6W/m.



Lynx Basic
4,8W/m IP20



	Cod.		
	52001	20	2
	52002	20	2

Lynx Basic
9,6W/m IP20



	Cod.		
	52005	20	2
	52006	20	2

Lynx Basic
4,8W/m IP65



	Cod.		
	52003	20	1
	52004	20	2

Lynx Basic
9,6W/m IP65



	Cod.		
	52007	20	1
	52008	20	2



LYNX PREMIUM 12 DC

LYNX PREMIUM 4,8W/M IP20 12DC



Planiranje

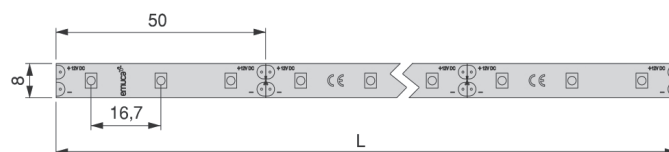

Intenzitet svetla (lx)

0,25 m	120°	943 lx
0,50 m		319 lx
0,75 m		162 lx
1,00 m		95 lx
1,25 m		63 lx

L	Lumen	Jačina	Efikasnost	Boja svetlosti	Broj dioda	Šifra
5m	410 lm/m	4,8 W/m	85 lm/W	6000K	60 Dioda/m	5200920
10m	410 lm/m	4,8 W/m	85 lm/W	4000K	60 Dioda/m	5201020
5m	410 lm/m	4,8 W/m	85 lm/W	3000K	60 Dioda/m	5201120

LYNX PREMIUM 9,6W/M IP20 12DC



Planiranje

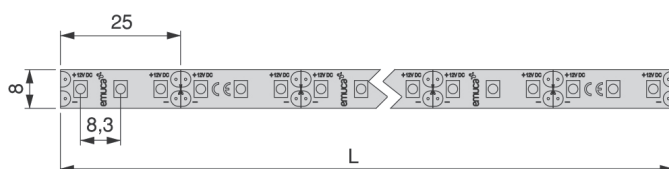

Intenzitet svetla (lx)

0,25 m	120°	1.947 lx
0,50 m		675 lx
0,75 m		341 lx
1,00 m		203 lx
1,25 m		153 lx

L	Lumen	Jačina	Efikasnost	Boja svetlosti	Broj dioda	Šifra
5m	805 lm/m	9,6 W/m	84 lm/W	6000K	120 Dioda/m	5201420
10m	805 lm/m	9,6 W/m	84 lm/W	4000K	120 Dioda/m	5201520
5m	805 lm/m	9,6 W/m	84 lm/W	3000K	120 Dioda/m	5201620

LYNX PREMIUM 14,4W/M IP20 12DC

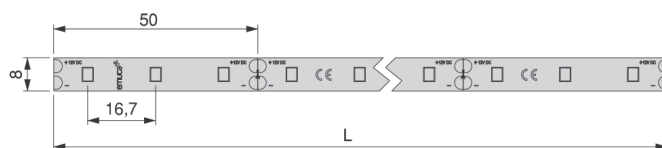
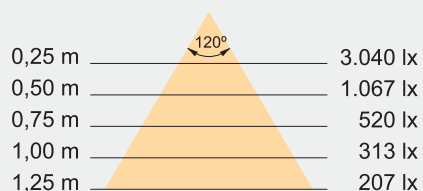
Planiranje

Intenzitet svetla (lx)

L	Lumen	Jačina	Efikasnost	Boja svetlosti	Broj dioda	Šifra
5m	1,200 lm/m	14,4 W/m	83 lm/W	6000K	60 Dioda/m	5201920
5m	1,200 lm/m	14,4 W/m	83 lm/W	4000K	60 Dioda/m	5202020
5m	1,200 lm/m	14,4 W/m	83 lm/W	3000K	60 Dioda/m	5202120

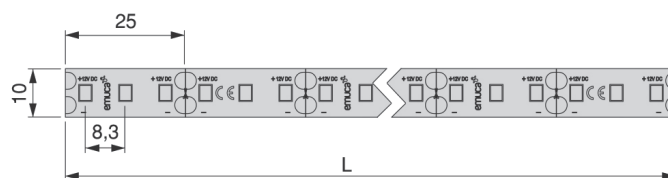
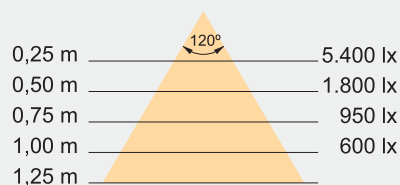
LYNX PREMIUM 28,8W/M IP20 12DC

Planiranje

Intenzitet svetla (lx)

L	Lumen	Jačina	Efikasnost	Boja svetlosti	Broj dioda	Šifra
5m	2,700 lm/m	28,8 W/m	94 lm/W	4000K	120 Dioda/m	5202420

LYNX PREMIUM CCT ADJUSTABLE 28,8W/M IP65 12DC

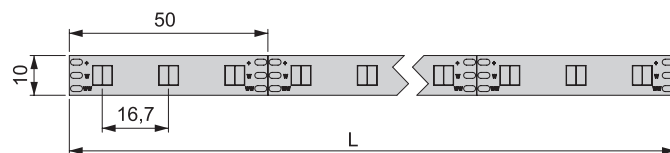

Planiranje



Intenzitet svetla (lx)

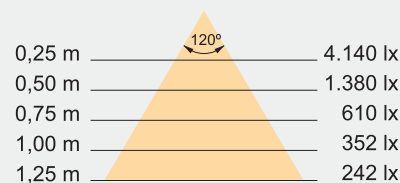

L	Lumen	Jačina	Efikasnost	Boja svetlosti	Broj dioda	Šifra
5m	2,050 lm/m	28,8 W/m	71 lm/W	3.000 ~ 6.000K	60 Dioda/m	5202620

KONTROLER

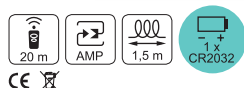

Planiranje

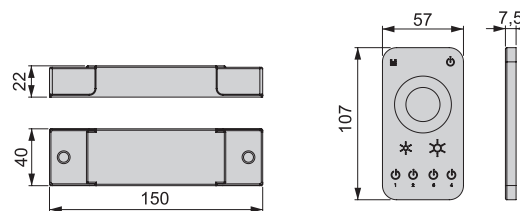

Naziv artikla	Šifra
KONTROLER	5202720

KABAL



Planiranje

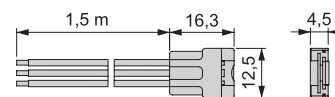

Naziv artikla	Šifra
KABAL 1,5m	5203020

KONEKTOR



Planiranje

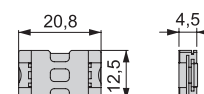

Naziv artikla	Šifra
KONEKTOR	5203120

LYNX PREMIUM RGB 14,4W/M IP65 12DC

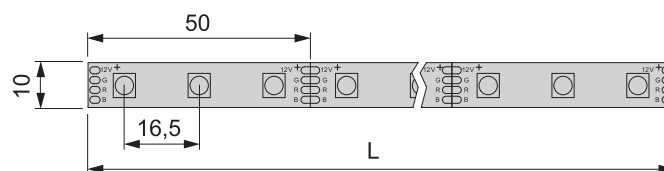
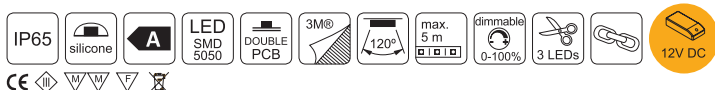
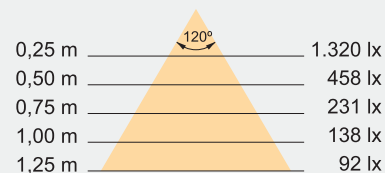
Planiranje

Intenzitet svetla (lx)

L	Lumen	Jačina	Efikasnost	Boja svetlosti	Broj dioda	Šifra
5m	960 lm/m	14,4 W/m	67 lm/W		60 Dioda/m	5020815

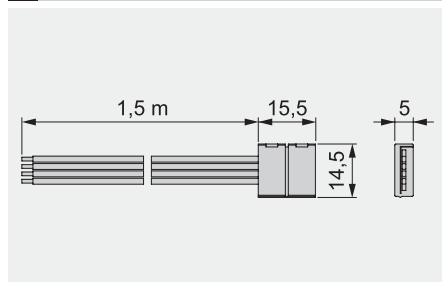
LED KABAL

Planiranje

Naziv artikla	Šifra
LED KABAL	5020620

LED KONEKTOR

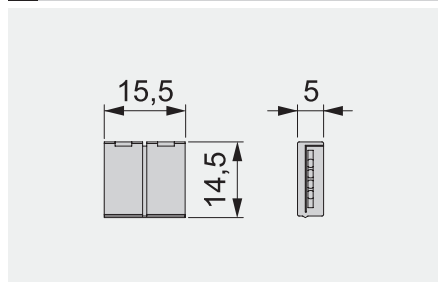
Planiranje

Naziv artikla	Šifra
LED KONEKTOR	5020920

LED KONEKTOR "L"

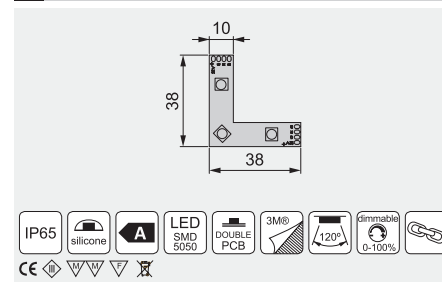
Planiranje

Naziv artikla	Šifra
L KONEKTOR	5020715

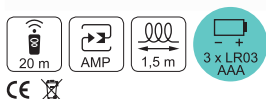
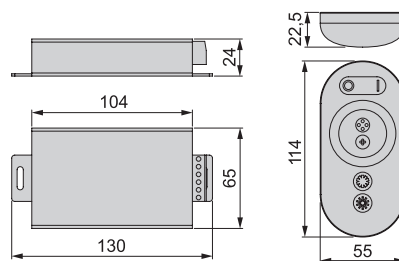
KONTROLER

Planiranje

Naziv artikla	Šifra
KONTROLER	5020520

LYNX BASIC 12DC

LYNX BASIC 4,8W/M IP20 12DC



Planiranje

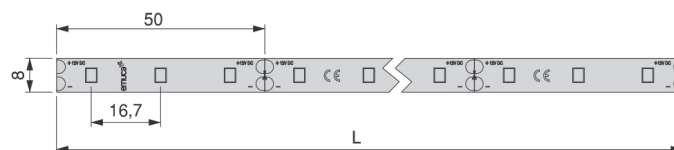

Intenzitet svetla (lx)

0,25 m	695 lx
0,50 m	242 lx
0,75 m	125 lx
1,00 m	72 lx
1,25 m	47 lx

L	Lumen	Jačina	Efikasnost	Boja svetlosti	Broj dioda	Šifra
5m	330 lm/m	4,8 W/m	69 lm/W	6000K	60 Dioda/m	5200120
5m	330 lm/m	4,8 W/m	69 lm/W	3000K	60 Dioda/m	5200220

LYNX BASIC 4,8W/M IP65 12DC



Planiranje

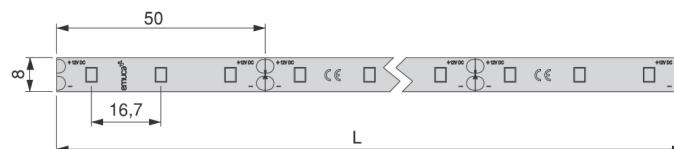

Intenzitet svetla (lx)

0,25 m	502 lx
0,50 m	171 lx
0,75 m	85 lx
1,00 m	50 lx
1,25 m	

L	Lumen	Jačina	Efikasnost	Boja svetlosti	Broj dioda	Šifra
5m	330 lm/m	4,8 W/m	69 lm/W	6000K	60 Dioda/m	5200320
5m	330 lm/m	4,8 W/m	69 lm/W	3000K	60 Dioda/m	5200420

LYNX BASIC 9,6W/M IP20 12DC

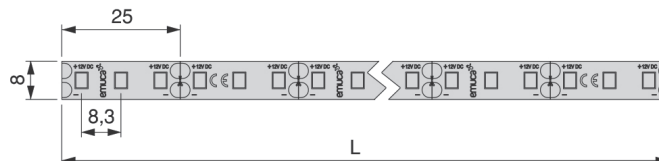
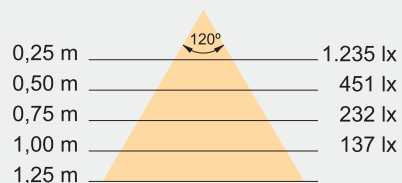
Planiranje

Intenzitet svetla (lx)

L	Lumen	Jačina	Efikasnost	Boja svetlosti	Broj dioda	Šifra
5m	660 lm/m	9,6 W/m	69 lm/W	6000K	120 Dioda/m	5200520
5m	660 lm/m	9,6 W/m	69 lm/W	3000K	120 Dioda/m	5200620

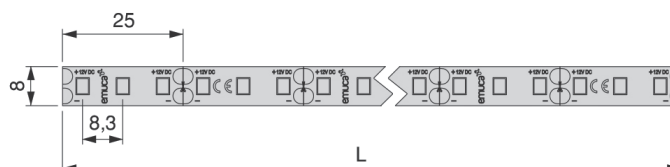
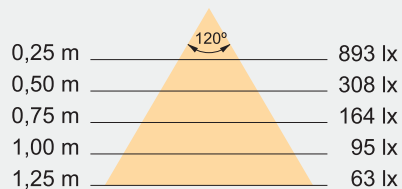
LYNX BASIC 9,6W/M IP65 12DC

Planiranje

Intenzitet svetla (lx)

L	Lumen	Jačina	Efikasnost	Boja svetlosti	Broj dioda	Šifra
5m	660 lm/m	9,6 W/m	69 lm/W	6000K	120 Dioda/m	5200720
5m	660 lm/m	9,6 W/m	69 lm/W	3000K	120 Dioda/m	5200820

LYNX PREMIUM 24 DC

LYNX PREMIUM 4,8W/m IP20 24DC



Planiranje

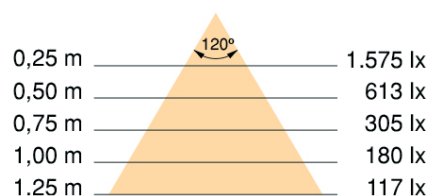
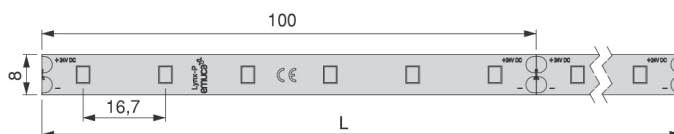

L	Lumen	Jačina	Efikasnost	Boja svetlosti	Broj dioda	Šifra	
10m	440 lm/m	4,8 W/m	91 lm/W	4000K	60 Dioda/m	5205120	1
10m	440 lm/m	4,8 W/m	91 lm/W	2700K	60 Dioda/m	5205220	1

LYNX PREMIUM 9,6W/m IP20 24DC



Planiranje

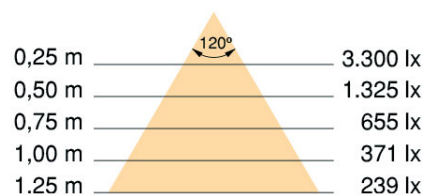
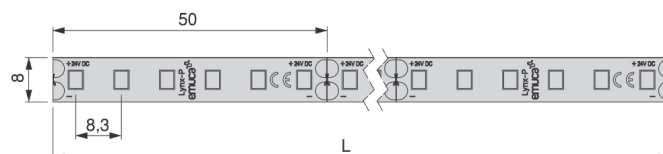

L	Lumen	Jačina	Efikasnost	Boja svetlosti	Broj dioda	Šifra	
10m	910 lm/m	9,6 W/m	94 lm/W	4000K	120 Dioda/m	5205320	1
10m	910 lm/m	9,6 W/m	94 lm/W	2700K	120 Dioda/m	5205420	1

NEONLYNX 24DC

LED TRAKE NEONLYNX 7,6W/m IP65 24DC



Planiranje

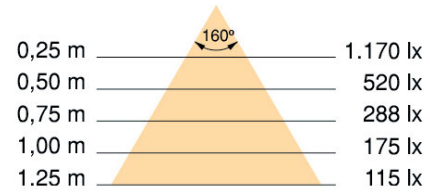
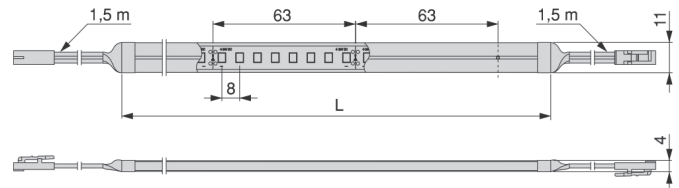

L	Lumen	Jačina	Efikasnost	Boja svetlosti	Broj dioda	Šifra	
1008mm	375 lm/m	7,6 W/m	49 lm/W	4000K	128 Dioda/m	5204220	8
3024mm	375 lm/m	7,6 W/m	49 lm/W	4000K	128 Dioda/m	5204320	2
5040mm	375 lm/m	7,6 W/m	49 lm/W	4000K	128 Dioda/m	5204420	2
1008mm	375 lm/m	7,6 W/m	49 lm/W	2700K	128 Dioda/m	5206020	8
3024mm	375 lm/m	7,6 W/m	49 lm/W	2700K	128 Dioda/m	5206120	2
5040mm	375 lm/m	7,6 W/m	49 lm/W	2700K	128 Dioda/m	5206220	2

Montaža

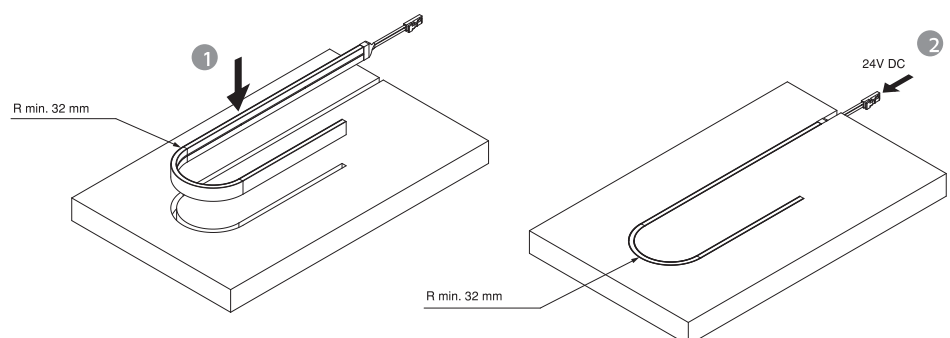
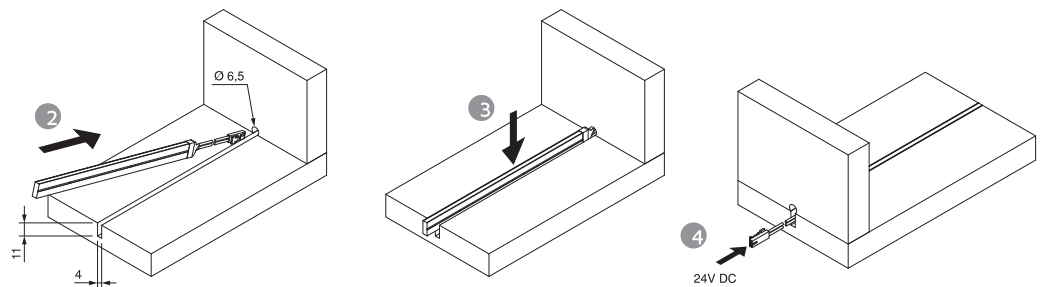
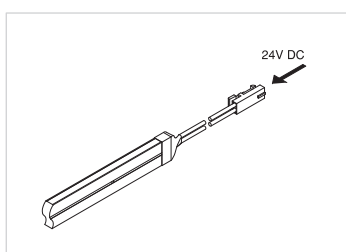
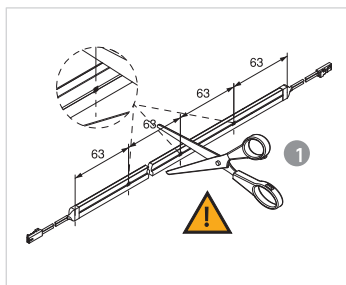
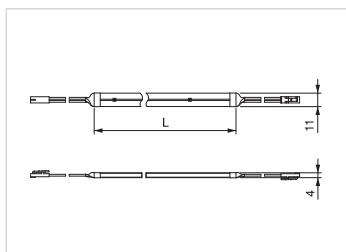

LED KONEKTORI 12DC

LYNX H KABL



Planiranje

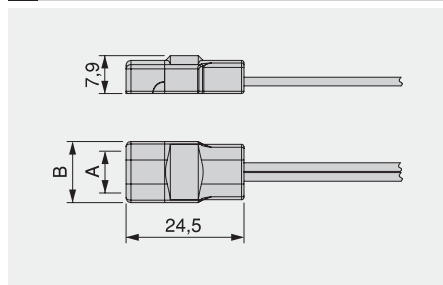

Naziv artikla	Šifra
LYNX H KABL 8mm	5061020
LYNX H KABL 10mm	5061220

LYNH H KONEKTOR



Planiranje

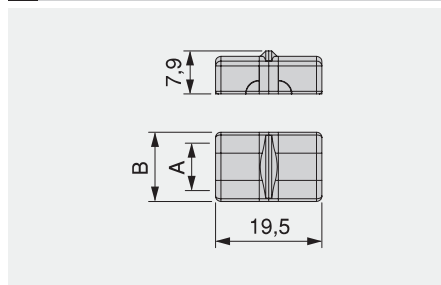

Naziv artikla	Šifra
LYNH H KONEK. 8mm	5061120
LYNH H KONEK. 10mm	5061320

LYNX Q KABL



Planiranje

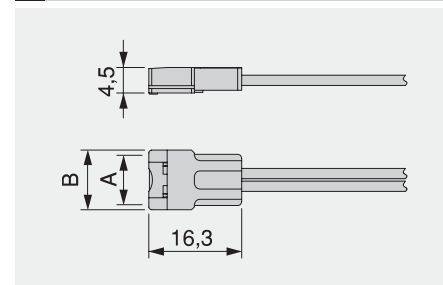

Naziv artikla	Šifra
LYNX Q KABL 8mm	7015417
LYNX Q KABL 10mm	5063920

LYNX Q KONEKTOR



Planiranje

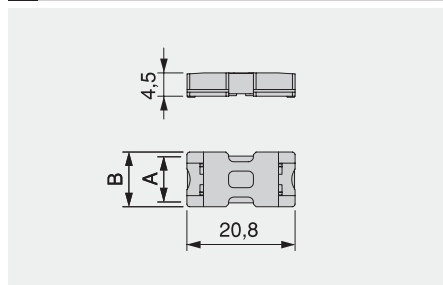

Naziv artikla	Šifra
LYNX Q KONEK. 8mm	7015520
LYNX Q KONEK. 10mm	5064020

LYNX Q FLEKSIBILNI KONEK.



Planiranje

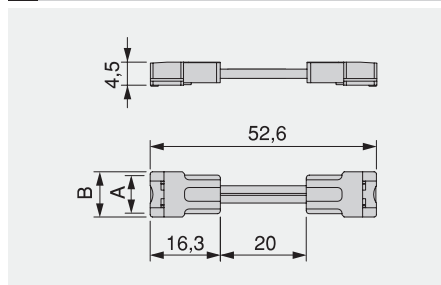

Naziv artikla	Šifra
LYNX Q FLEKS KONEK.	5203220

LYNX L KONEKTOR



Planiranje

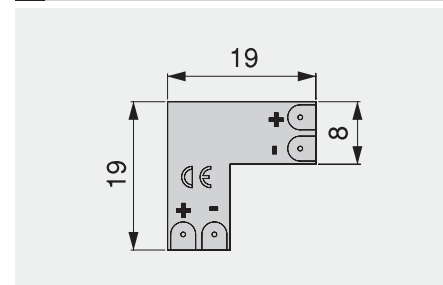

Naziv artikla	Šifra
LYNX L KONEKTOR	5202820

X KONEKTOR

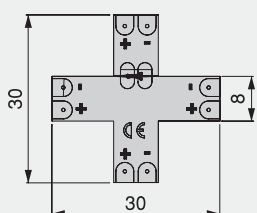
Planiranje

Naziv artikla	Šifra
X KONEKTOR	5202920

IP44 ZAŠTITA

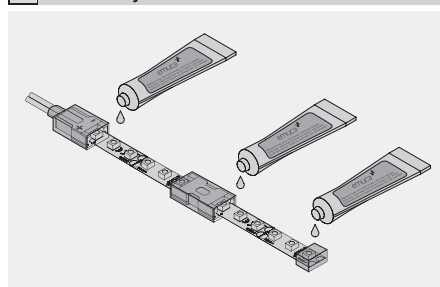
Planiranje

Naziv artikla	Šifra
IP44 ZAŠTITA	5017420

IP44 LED KONEKTOR

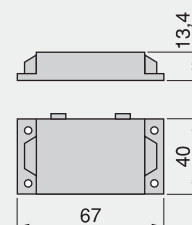
Planiranje

Naziv artikla	Šifra
IP44 LED KONEKTOR	5017220

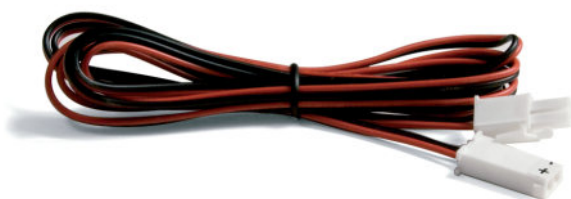
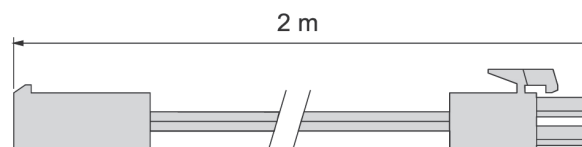
LED KABL EXTENSION 12V AMP 2M

Planiranje

Naziv artikla	Šifra
LED KABL EXTENSION 12V AMP 2M	9269817

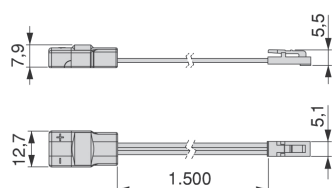
LED KONEKTORI 24DC
LYNX H LED KABL 24DC

Planiranje

Naziv artikla	Šifra
LYNX H LED KABL 24DC	5204820

LYNX H LED KABL EXT. 2M 24DC

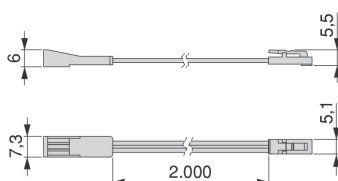
Planiranje

Naziv artikla	Šifra
LYNX H LED KABL EXT. 2M 24DC	5204920

ADAPT. AMP ZA SENZ. 12-24 DC

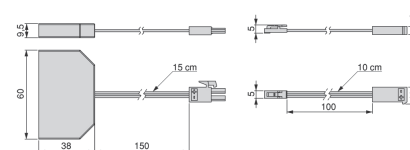
Planiranje

Naziv artikla	Šifra
ADAPTER AMP 12-24DC	5205020

LED SENZORI 12DC

LYNX SENZOR NA POKRET 12DC

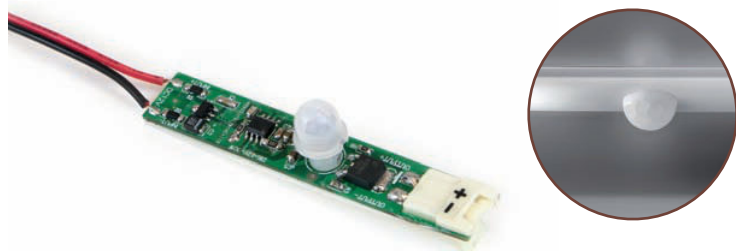

Planiranje

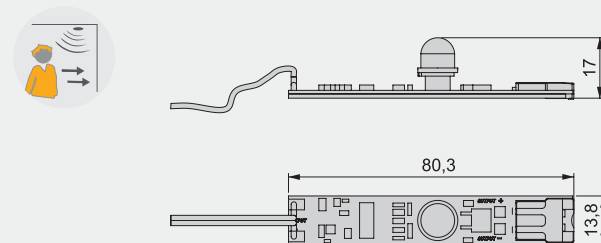

Max Snaga	Ulaz	Izlaz	Šifra
30 W	12V DC	12V DC	5203720

LYNX SENZOR NA DODIR/DIMER 12DC

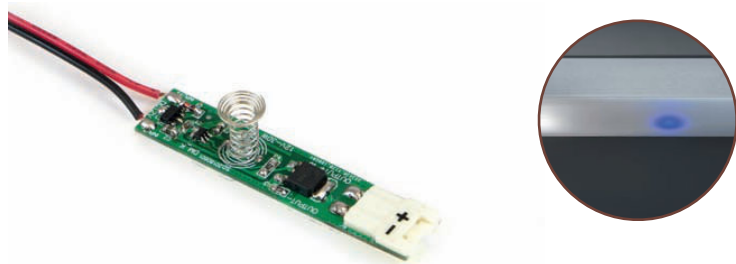

Planiranje

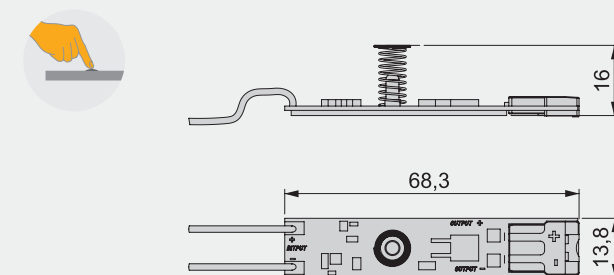

Max Snaga	Ulaz	Izlaz	Šifra
30 W	12V DC	12V DC	5203520
30 W (DIMER)	12V DC	12V DC	5203620

SENZOR SKRIVENI DODIR/DIMER 12DC

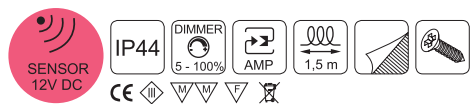
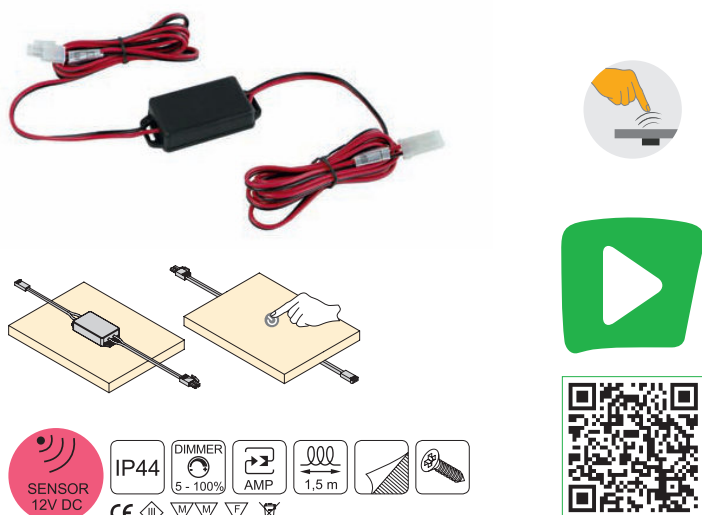

Planiranje

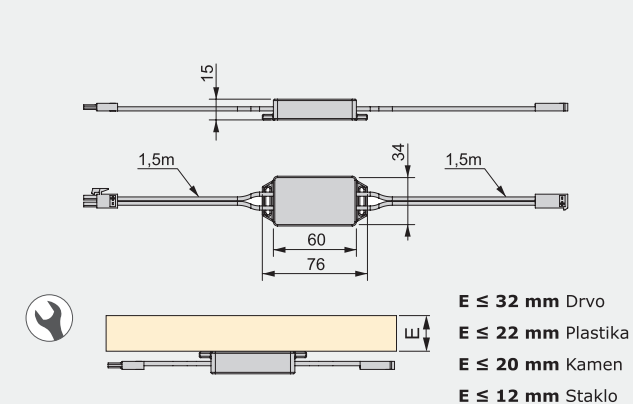

Max Snaga	Ulaz	Izlaz	Šifra
80 W	12V DC	12V DC	5022617

LED SENZORI 12DC/24DC

LYNX SENZOR SWITCH 12DC/24DC



Planiranje

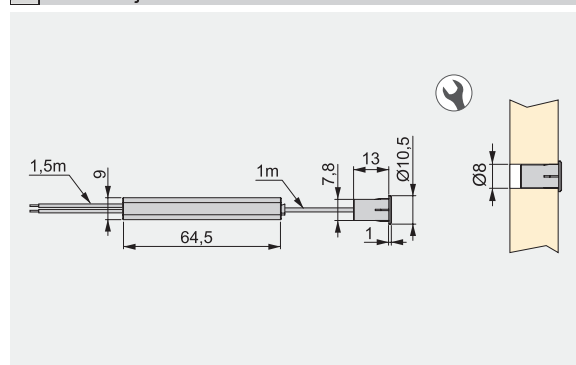

Max Snaga	Ulaz	Izlaz	Šifra
36 W (12V DC) - 72 W (24V DC)	12V DC - 24V DC	12V DC - 24V DC	5022925
36 W (12V DC) - 72 W (24V DC)	12V DC - 24V DC	12V DC - 24V DC	5023025

LYNX SENZOR ZA VRATA 12DC/24DC



Planiranje

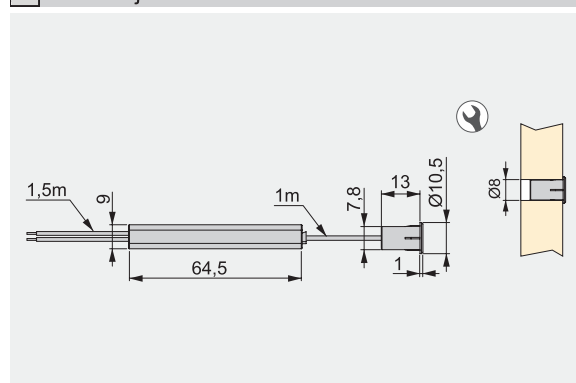

Max Snaga	Ulaz	Izlaz	Šifra
36 W (12V DC) - 72 W (24V DC)	12V DC - 24V DC	12V DC - 24V DC	5023225

LYNX SENZOR NA POKRET 12DC/24DC



Planiranje

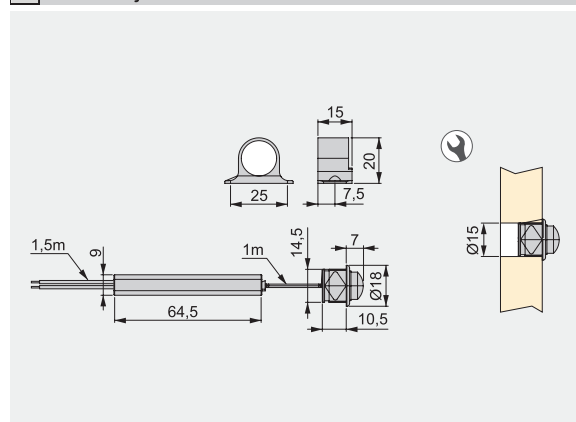

Max Snaga	Ulaz	Izlaz	Šifra
36 W (12V DC) - 72 W (24V DC)	12V DC - 24V DC	12V DC - 24V DC	5023120

MICRON PREKIDAČ/DIMER



Planiranje

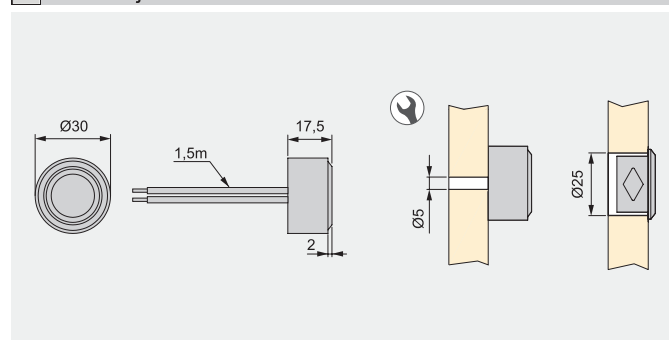

Max Snaga	Ulaz	Izlaz	Šifra
24 W (12V DC) - 48 W (24V DC)	12V DC - 24V DC	12V DC - 24V DC	5053125

LED SENZORI 240V AC

LYNX LED SENZOR NA DODIR SIMPLE 240V AC



Planiranje

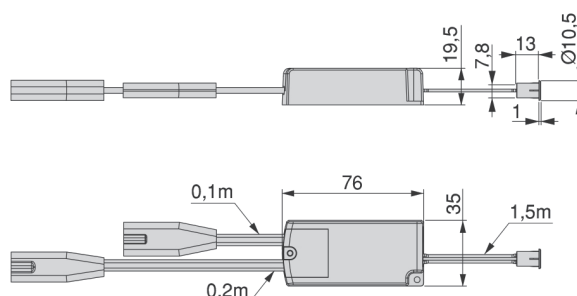

Max Snaga	Ulaz	Izlaz	Šifra
Max. 250 W	100-240V AC 50-60Hz	100-240V AC 50-60Hz	5040525

LYNX LED SENZOR SWITCH DOUBLE 240V AC



Planiranje

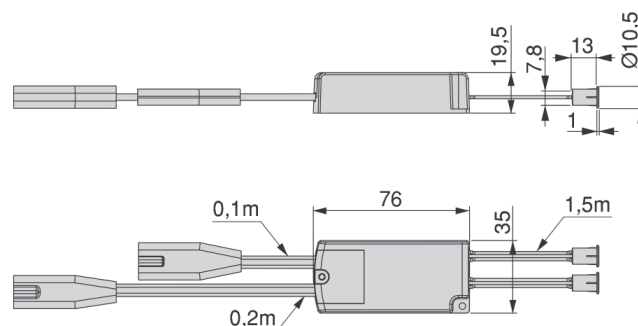

Max Snaga	Ulaz	Izlaz	Šifra
Max. 250 W	100-240V AC 50-60Hz	100-240V AC 50-60Hz	5040625

LYNX LED SENZOR ZA VRATA SIMPLE 240V AC

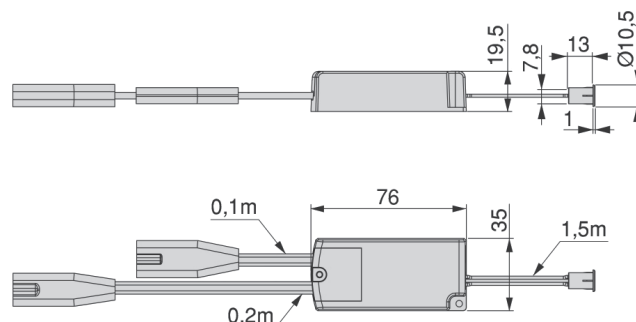
Planiranje

Max Snaga	Ulaz	Izlaz	Šifra
Max. 250 W	100-240V AC 50-60Hz	100-240V AC 50-60Hz	5040725

LYNX LED SENZOR ZA VRATA DOUBLE 240V AC

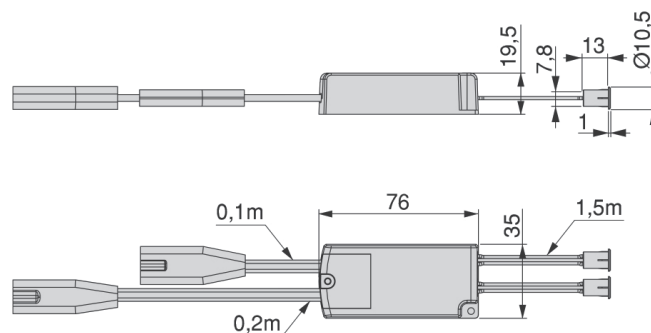
Planiranje

Max Snaga	Ulaz	Izlaz	Šifra
Max. 250 W	100-240V AC 50-60Hz	100-240V AC 50-60Hz	5040825

LED SENZOR NA POKRET 240V AC

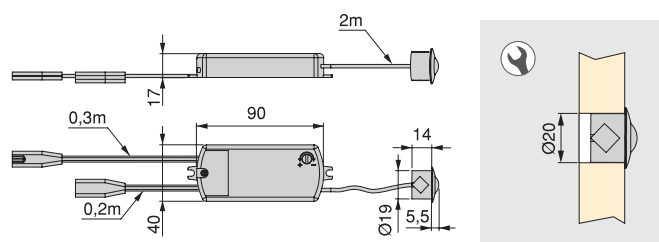
Planiranje

Max Snaga	Ulaz	Izlaz	Šifra
Max. 250 W	220-240V AC - 50Hz	220-240V AC 50-60Hz	7001820

LED SENZOR NA DODIR 240V AC



2 m



Planiranje

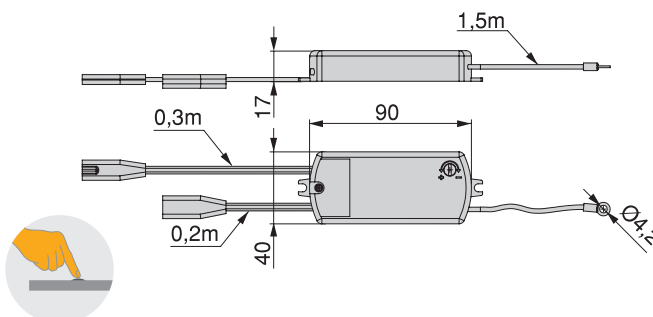

Max Snaga	Ulaz	Izlaz	Šifra
Max. 500 W	220-240V AC - 50Hz	220-240V AC 50-60Hz	7001920



LED PREKIDAČI

PREKIDAČ



Planiranje i montaža

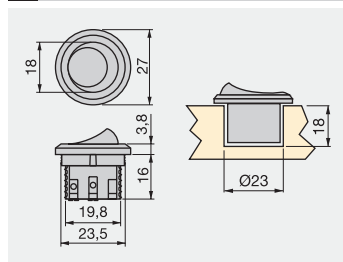

Naziv artikla	Šifra
PREKIDAČ SWITCH OF FI23X17 BELI	9638115
PREKIDAČ SWITCH OF FI23X17 CRNI	9638117

PREKIDAČ ZA VRATA



Planiranje i montaža

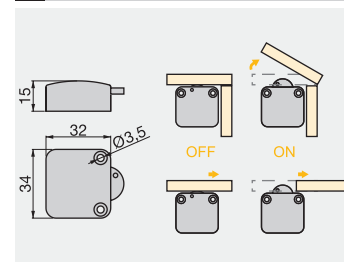

Naziv artikla	Šifra
EMUCA PREKIDAČ ZA VRATA 34X32 BELI	9642415
EMUCA PREKIDAČ ZA VRATA 34X32 CRNI	9642417

LED TRANSFORMATORI 12DC

LED TRANSFORMATORI



Planiranje

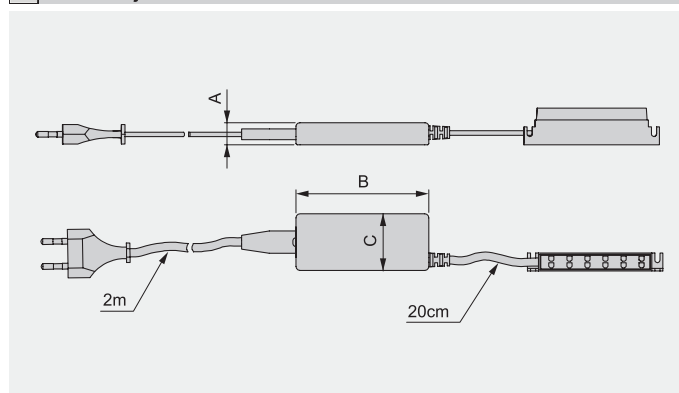

Naziv artikla	Šifra	WATT	A	B	C
LED TRANSFORMATOR 6W-12DC	7080920	6W	17	96	41
LED TRANSFORMATOR 15W-12DC	7001420	15W	17	96	41
LED TRANSFORMATOR 30W-12DC	7001320	30W	31	120	53
LED TRANSFORMATOR 50W-12DC	5008420	50W	31	120	53
LED TRANSFORMATOR 72W-12DC	5008520	72W	38	153	60

LED TRANSFORMATORI (HIGH POWER)



Planiranje

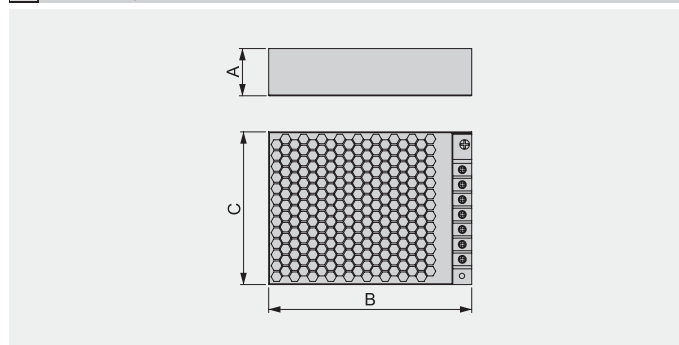

Naziv artikla	Šifra	WATT	A	B	C
LED TRANSFORMATORI (HIGH POWER) 100W	5203320	100W	30	129	97
LED TRANSFORMATORI (HIGH POWER) 200W	5203420	200W	30	215	115

LED TRANSFORMATORI (IP45)

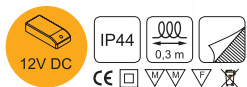

Planiranje

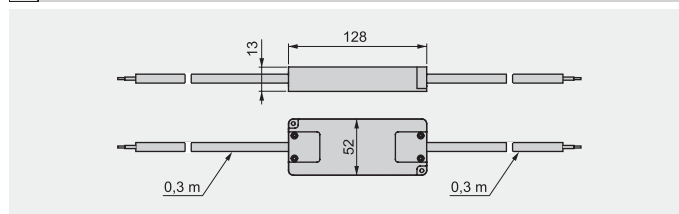

Naziv artikla	Šifra
LED TRANSFORMATORI (IP45)	5017320

LED TRANSFORMATORI 24DC

LED TRANSFORMATOR 15W 24DC



Planiranje

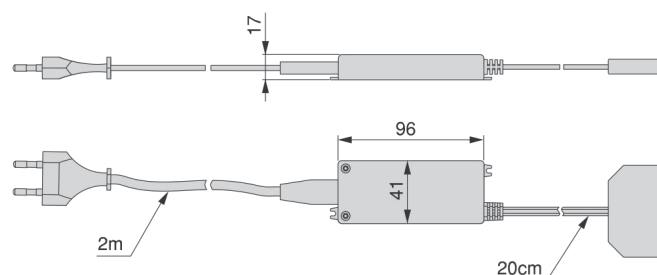

Jačina	Ulaz	Izlaz	Šifra
15 W	100-240V AC - 50-60Hz	24V DC	5204520

LED TRANSFORMATOR 50W 24DC



Planiranje

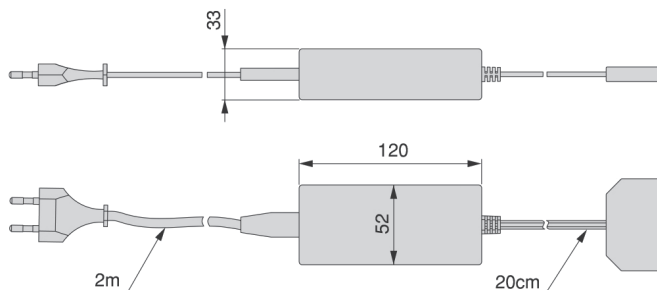

Jačina	Ulaz	Izlaz	Šifra
50 W	100-240V AC - 50-60Hz	24V DC	5204620

LED TRANSFORMATOR 100W 24DC



Planiranje

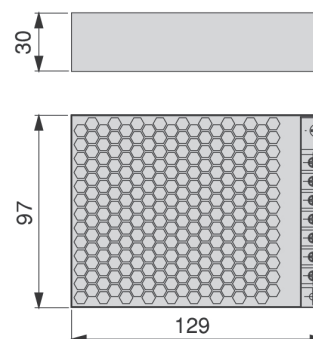

Jačina	Ulaz	Izlaz	Šifra
100 W	100-240V AC - 50-60Hz	24V DC	5204720

LED PROFILI I DIFUZORI
LED PROFILI UKOPAVAJUCI (ZAKRIVLJEN DIFUZOR)

Naziv artikla	Šifra
LED PROFIL ZA TRAKU UKOPAVAJUĆI LYNX L-2,9M	5085462
LED DIFUZOR ZA PROFIL UKOPAVAJUĆI LYNX L-2,9M	5147215
LED POKLOPAC ZA PROFIL, UKOPAVAJUĆI KRIVI	5144221

LED PROFILI UKOPAVAJUCI (RAVAN DIFUZOR)

Naziv artikla	Šifra
LED PROFIL ZA TRAKU UKOPAVAJUĆI RAVAN LYNX L-2,9M	5085562
LED DIFUZOR ZA PROFIL UKOPAVAJUĆI RAVNI LYNX L-2,9M	5147315
LED POKLOPAC ZA PROFIL, UKOPAVAJUĆI RAVNI	5146921
LED POKLOPAC + SET ZA DIFUZOR RAVNI	5146821

LED PROFILI NADGRADNI

Naziv artikla	Šifra
LED PROFIL ZA TRAKU NADGRADNI LYNX L-2,35M	5085062
LED DIFUZOR ZA PROFIL NADGRADNI LYNX L-2,35M	5147015
LED POKLOPAC ZA PROFIL, NADGRADNI	5143421

LED PROFILI UGAONI

Profil
 Difuzor
 Poklopac
 Montaža



Planiranje
 Planiranje
 Planiranje

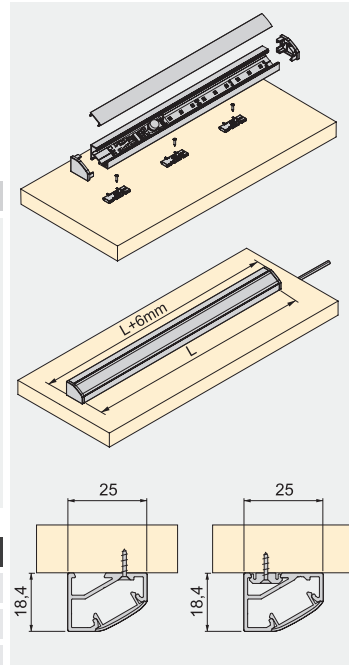
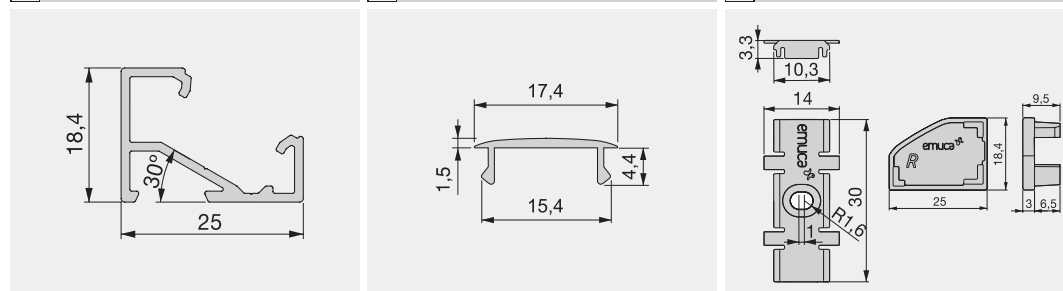

Naziv artikla	Šifra
LED PROFIL ZA TRAKU UGAONI LYNX L-2,9M	5085662
LED DIFUZOR ZA PROFIL KRIVI/UGAONI LYNX L-2,9M	5147215
LED POKLOPAC ZA PROFIL, UGAONI	5146321



LED LAMPE
CRUX

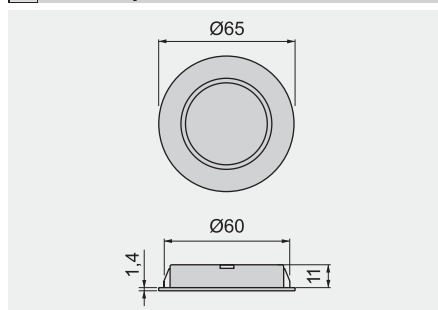
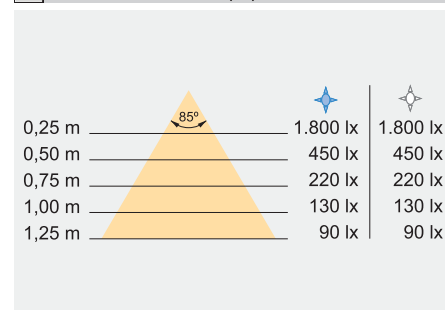

CE

Planiranje

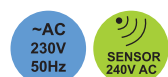
Intenzitet svetla (lx)

Naziv Artikla	Lumen (lm)	Jačina	Br. Led-a	Boja svetlosti	Obrada	Šifra
LED LAMPA CRUX	105	1,8 W	24	Hladno Bela 6000K	Alu mat	5914525
LED LAMPA CRUX	105	1,8 W	24	Hladno Bela 6000K	Nikl saten	5914551
LED LAMPA CRUX	110	1,8 W	24	Prirodno Bela 4500K	Alu mat	5914625
LED LAMPA CRUX	110	1,8 W	24	Prirodno Bela 4500K	Nikl saten	5914651

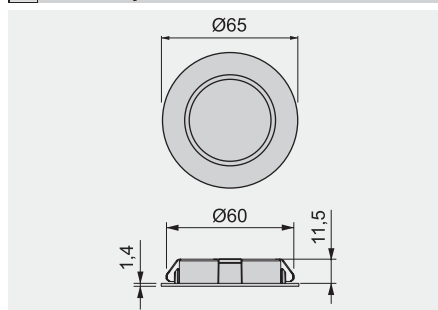
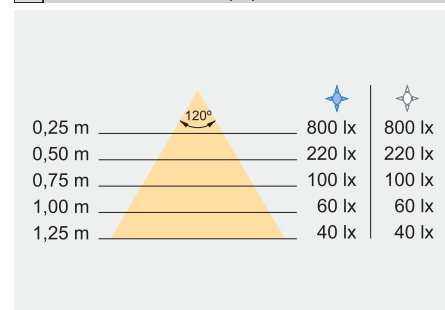
CRUX IN

CE

Planiranje

Intenzitet svetla (lx)

Naziv artikla	Lumen (lm)	Jačina	Br. Led-a	Boja svetlosti	Obrada	Šifra
LED LAMPA CRUX-IN	116	1,8 W	24	Hladno Bela 6000K	Alu mat	5915225
LED LAMPA CRUX-IN	116	1,8 W	24	Hladno Bela 6000K	Nikl saten	5915251
LED LAMPA CRUX-IN	127	1,8 W	24	Prirodno Bela 4000K	Nikl saten	5915351

LED PRSTEN

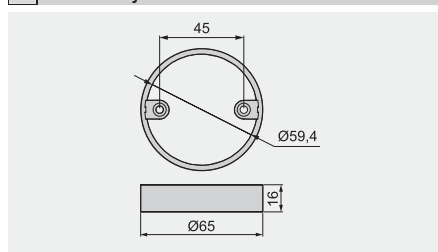

Planiranje



Naziv artikla	Šifra
PRSTEN ZA CRUX-IN ALU	5915525
PRSTEN ZA CRUX-IN N.SAT	5915551

CRUX-IN-Q

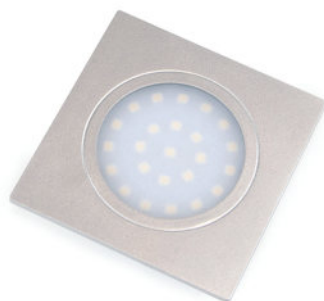

Planiranje

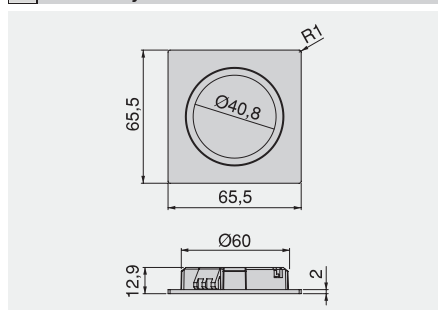

Intenzitet svetla (lx)

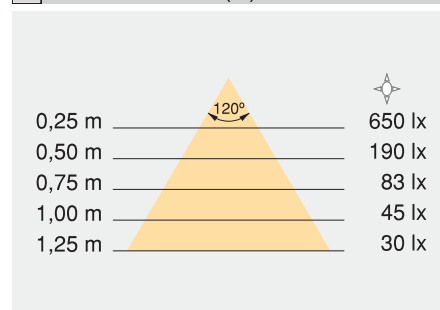

CE ◊ ◊ ◊ ◊ ◊ ◊

Naziv artikla	Lumen (lm)	Jačina	Br. Led-a	Boja svetlosti	Obrada	Šifra
CRUX-IN-Q	101	1,8 W	24	Prirodno Bela 4000K	Alu mat	5203925
CRUX-IN-Q	101	1,8 W	24	Prirodno Bela 4000K	Nikl saten	5203951
CRUX-IN-Q	101	1,8 W	24	Prirodno Bela 4000K	Bela	5203912
CRUX-IN-Q	101	1,8 W	24	Prirodno Bela 4000K	Crna	5203914

HIDRA



Planiranje

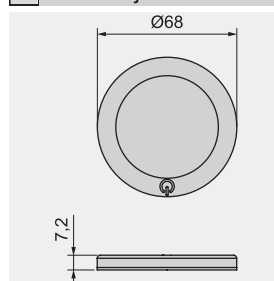

Intenzitet svetla (lx)

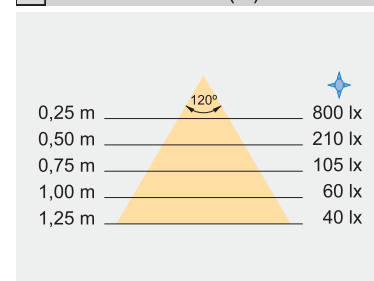

CE ◊ ◊ ◊ ◊ ◊ ◊

Naziv artikla	Lumen (lm)	Jačina	Br. Led-a	Boja svetlosti	Obrada	Šifra
HIDRA	130	2 W	24	Hladno Bela 6000K	Alu mat	5050625

ANDROMET

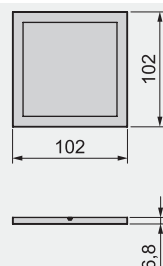
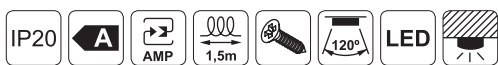
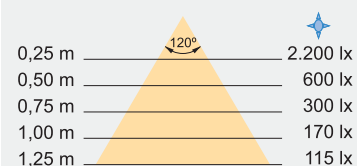
Planiranje

Intenzitet svetla (lx)

CE

Naziv artikla	Lumen (lm)	Jačina	Br. Led-a	Boja svetlosti	Obrada	Šifra
ANDROMET	330	6 W	24	Hladno Bela 6000K	Nikl saten	5050525

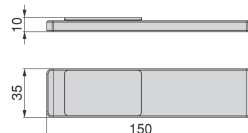
AURIGA

Planiranje

Intenzitet svetla (lx)

CE

Naziv artikla	Lumen (lm)	Jačina	Br. Led-a	Boja svetlosti	Obrada	Šifra
AURIGA	205	2,5 W	6	Prirodno Bela 4000K	Alu mat	5204162

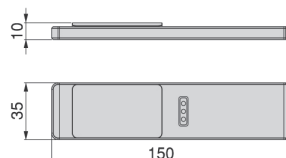
AURIGA SWITCH

Planiranje

Intenzitet svetla (lx)

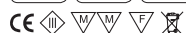
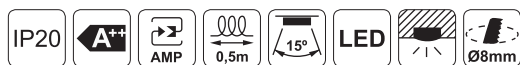

CE

Naziv artikla	Lumen (lm)	Jačina	Br. Led-a	Boja svetlosti	Obrada	Šifra
AURIGA SWITCH	205	2,5 W	6	Prirodno Bela 4000K	Alu mat	5204062

LED SPOT

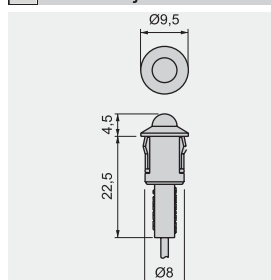

Planiranje



Intenzitet svetla (lx)

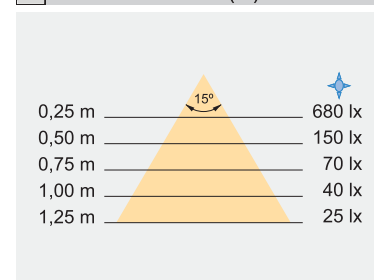

Naziv artikla	Lumen (lm)	Jačina	Br. Led-a	Boja svetlosti	Obrada	Šifra
LED SPOT	9	0,3 W	1	Hladno Bela 6000K	Hrom	7015611

PHOENIX



Planiranje

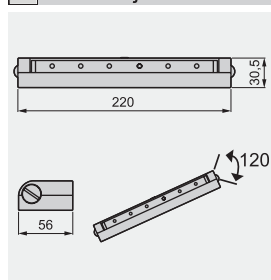

Intenzitet svetla (lx)

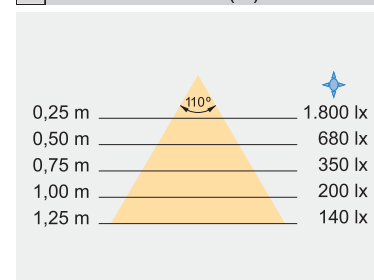

Naziv artikla	Lumen (lm)	Jačina	Br. Led-a	Boja svetlosti	Obrada	Šifra
PHOENIX	30	0,6 W	6	Hladno Bela 7000K	Alu mat	5004125

DRAWLED



Planiranje

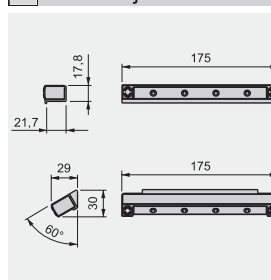

Intenzitet svetla (lx)

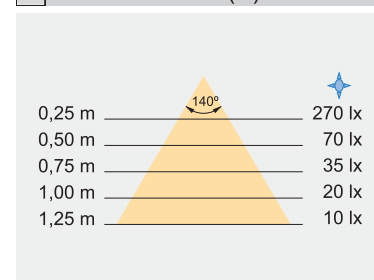

Naziv artikla	Lumen (lm)	Jačina	Br. Led-a	Boja svetlosti	Obrada	Šifra
DRAWLED	28	0,6 W	4	Hladno Bela 7000K	Alu mat	5006325

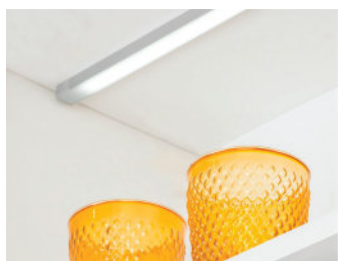
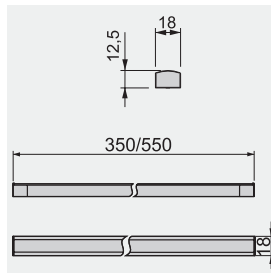
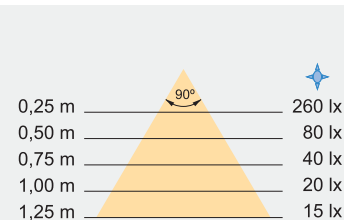
DIFLEX

Planiranje

Intenzitet svetla (lx)

CE

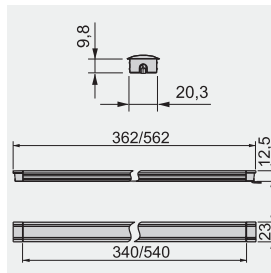
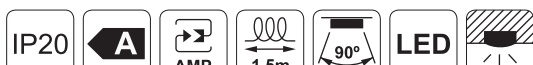
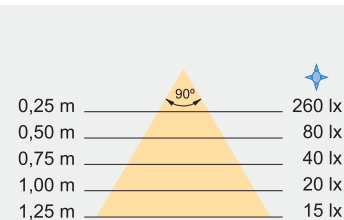
Naziv artikla	Lumen (lm)	Jačina	Br. Led-a	Boja svetlosti	Obrada	Šifra
DIFLEX L-350MM	101	2,4 W	27	Hladno Bela 6000K	Alu mat	5144562
DIFLEX L-550MM	182	4,3 W	54	Hladno Bela 6000K	Alu mat	5144662

DIFLEX IN

Planiranje

Intenzitet svetla (lx)

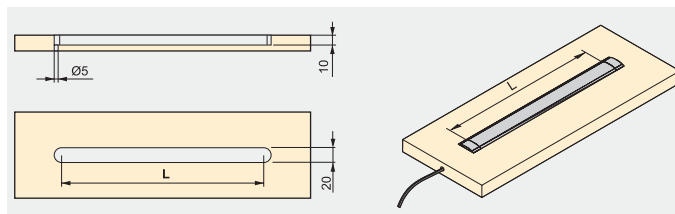
CE

Montaža

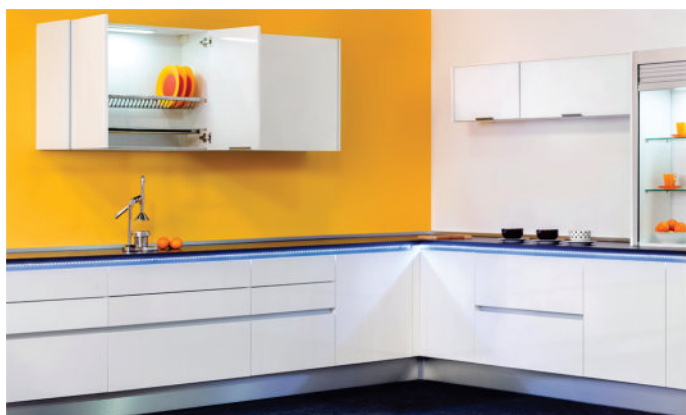
Naziv artikla	Lumen (lm)	Jačina	Br. Led-a	Boja svetlosti	Obrada	Šifra
DIFLEX IN L-340MM	113	2,7 W	30	Hladno Bela 6000K	Alu mat	5144362
DIFLEX IN L-540MM	203	4,6 W	54	Hladno Bela 6000K	Alu mat	5144462



KUMA CIRCULAR



Planiranje

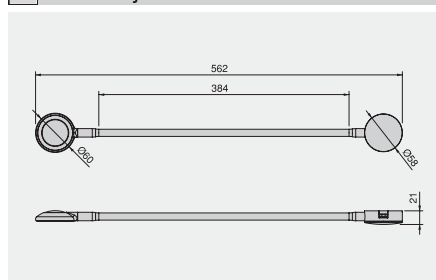

Intenzitet svetla (lx)

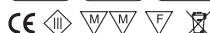
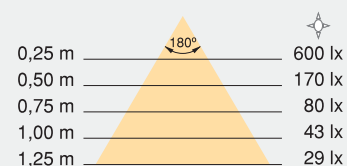

Naziv artikla	Lumen (lm)	Jačina	Br. Led-a	Boja svetlosti	Obrada	Šifra
KUMA CIRCULAR	150	2,1 W	16	Prirodno Bela 4000K	Bela	5029315
KUMA CIRCULAR	150	2,1 W	16	Prirodno Bela 4000K	Crna	5029317

CASTOR SVETLEĆA GARDEROBNA ŠIPKA



Planiranje

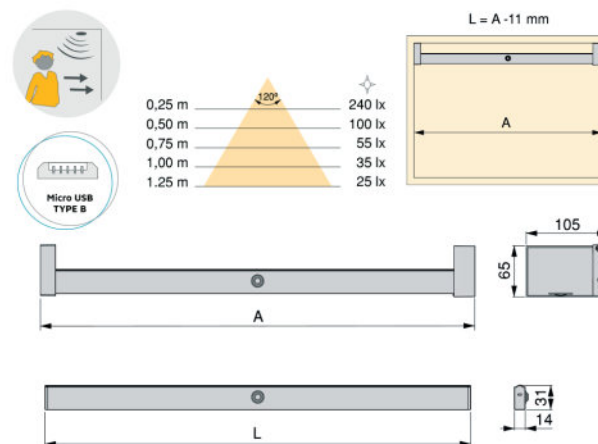

A	L	OD - DO	Lumen (lm)	Jačina	Br. Led-a	Boja svetlosti	Obrada	Šifra
558	547	408-558	30 lm	0,6 W	30	Prirodno Bela 4000K	Alu mat	5074062
558	547	408-558	30 lm	0,6 W	30	Prirodno Bela 4000K	Moka	5074013
708	697	558-708	35 lm	0,7 W	45	Prirodno Bela 4000K	Alu mat	5074162
708	697	558-708	35 lm	0,7 W	45	Prirodno Bela 4000K	Moka	5074113
858	847	708-858	45 lm	0,9 W	60	Prirodno Bela 4000K	Alu mat	5074262
858	847	708-858	45 lm	0,9 W	60	Prirodno Bela 4000K	Moka	5074213
1008	997	858-1008	50 lm	1 W	75	Prirodno Bela 4000K	Alu mat	5074362
1008	997	858-1008	50 lm	1 W	75	Prirodno Bela 4000K	Moka	5074313
1158	1147	1008-1158	55 lm	1,2 W	90	Prirodno Bela 4000K	Alu mat	5074462
1158	1147	1008-1158	55 lm	1,2 W	90	Prirodno Bela 4000K	Moka	5074413

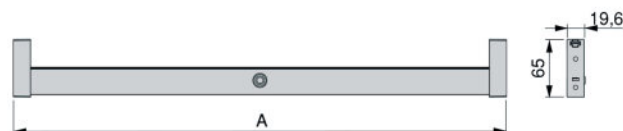
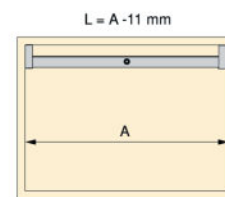
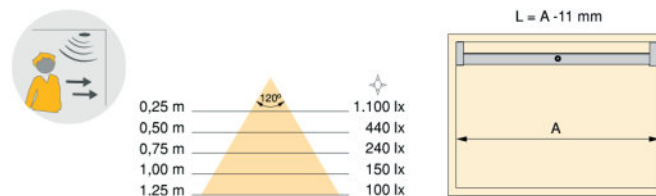
POLUX SVETLEĆA GARDEROBNA ŠIPKA 12DC
Planiranje

A	L	OD - DO	Lumen (lm)	Jačina	Br. Led-a	Boja svetlosti	Obrada	Šifra
558	547	408-558	125 lm	2,6 W	32	Prirodno Bela 4000K	Alu mat	5074562
708	697	558-708	160 lm	3,3 W	41	Prirodno Bela 4000K	Alu mat	5074662
858	847	708-858	190 lm	4 W	50	Prirodno Bela 4000K	Alu mat	5074762
1008	997	858-1008	230 lm	4,8 W	59	Prirodno Bela 4000K	Alu mat	5074862
1158	1147	1008-1158	260 lm	5,5 W	68	Prirodno Bela 4000K	Alu mat	5074962

AQUARIUS (300mm, 450mm)

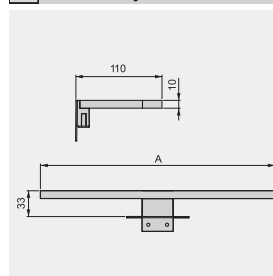
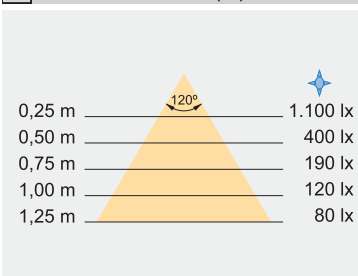
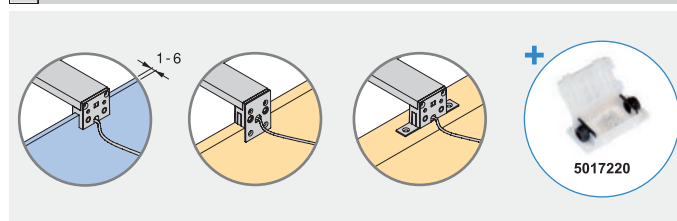
Planiranje

Intenzitet svetla (lx)

Montaža

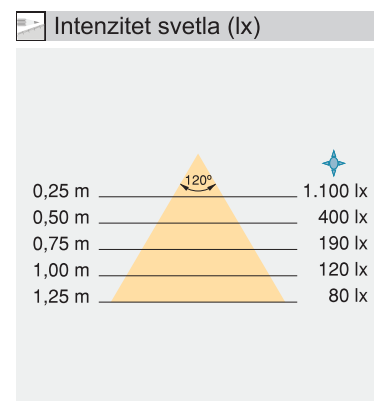
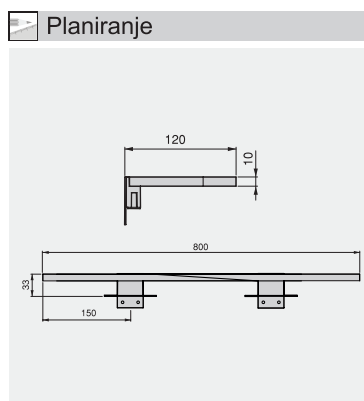
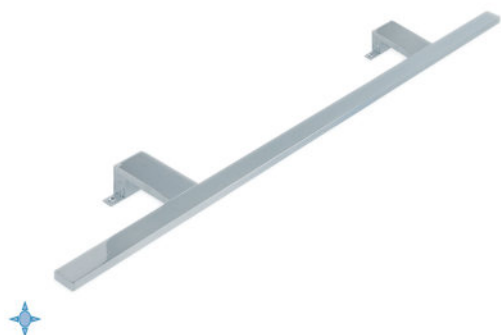
Naziv Artikla	Lumen (lm)	Jačina	Br. Led-a	Boja svetlosti	Obrada	Šifra
AQUARIUS L-300	520	7 W	60	Hladno Bela 6000K	Hrom	5145311
AQUARIUS L-450	480	7 W	60	Hladno Bela 6000K	Hrom	5145411

AQUARIUS (800mm)



Naziv artikla	Lumen (lm)	Jačina	Br. Led-a	Boja svetlosti	Obrada	Šifra
AQUARIUS L-800	800	14 W	120	Hladno Bela 6000K	Hrom	5145611

SAGITARIUS

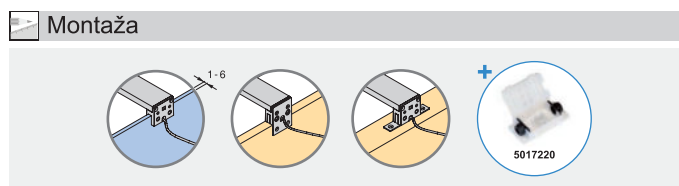
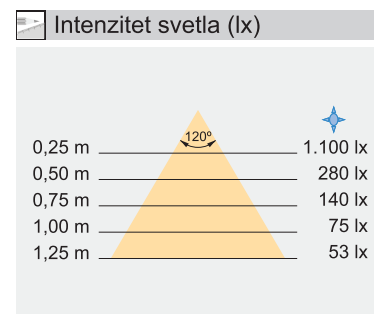
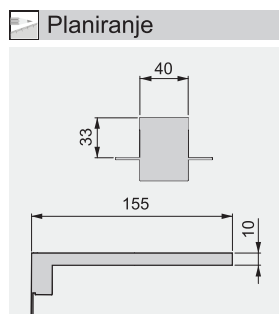

Naziv artikla	Lumen (lm)	Jačina	Br. Led-a	Boja svetlosti	Obrada	Šifra
SAGITARIUS L-40	380	5 W	30	Hladno Bela 6000K	Hrom	5145711

SAGITARIUS (300mm, 450mm)

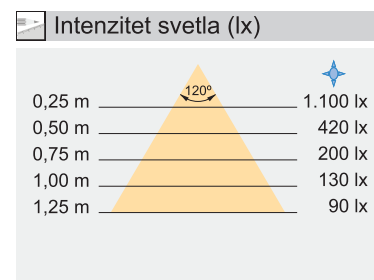
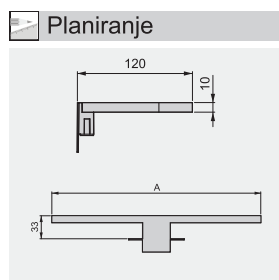

Naziv artikla	Lumen (lm)	Jačina	Br. Led-a	Boja svetlosti	Obrada	Šifra
SAGITARIUS L-350	550	7 W	60	Hladno Bela 6000K	Hrom	5145811
SAGITARIUS L-450	530	7 W	60	Hladno Bela 6000K	Hrom	5145911

SAGITARIUS (800mm)

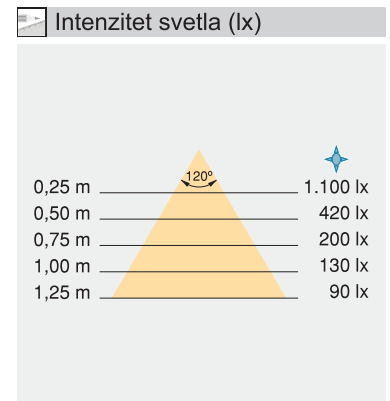
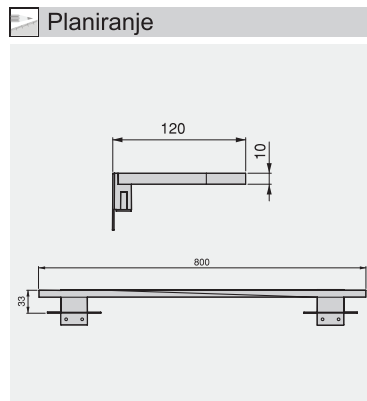

Naziv artikla	Lumen (lm)	Jačina	Br. Led-a	Boja svetlosti	Obrada	Šifra
SAGITARIUS L-800MM	900	14	120	Hladno Bela 6000K	Hrom	5146111

