



7

RUČICE I KUKE ZA NAMEŠTAJ

RUČICE I KUKE ZA NAMEŠTAJ

7.1 RUČICE	231
STANDARDNE	231
PROFILI	243
UKOPAVAJUĆE	244
7.2 KUKE	246



STANDARDNE

RUČICA D-1

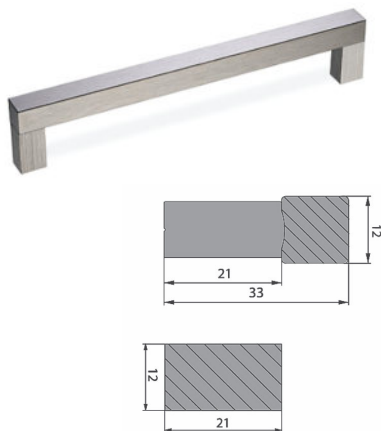

Promer za bušenje	∑ dužina	Obrada (Šifra)		
		Siva	Hrom	Crna
096	108	7161	7223	
128	140	7162	7224	7235
160	172	7163	7225	7236
192	204	7164	7226	7237
224	236	7165	7227	7238
320	332	7168	7230	7241

RUČICA D-2

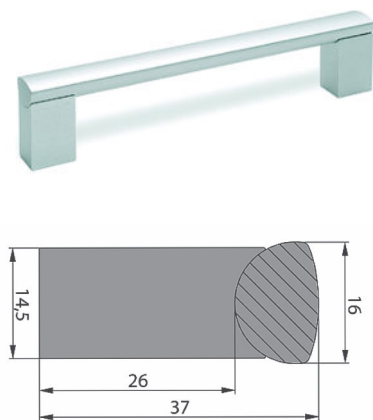

Promer za bušenje	∑ dužina	Obrada (Šifra)	
		Siva	Hrom
096	116	18.T78.096.09	
128	148	18.T78.128.09	7195
160	180	18.T78.160.09	7196
192	212	18.T78.192.09	7197
224	244	18.T78.224.09	7198
256	276	18.T78.256.09	7199
320	340	18.T78.320.09	7201

RUČICA D-3



Promer za bušenje	∑ dužina	Obrada (Šifra)
		Siva/Hrom
160	170	7282
192	202	7283
224	234	7284
320	330	7287

RUČICA D-4

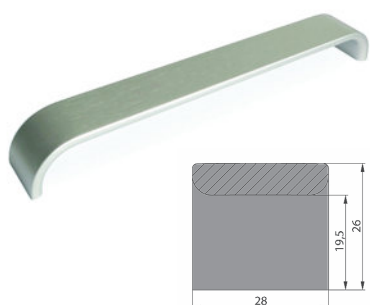

Promer za bušenje	∑ dužina	Obrada (Šifra)		
		Siva	Crna	Bela
160	221	7355	7617	7605
192	240	7356	7618	7606
224	272	7357	7619	7607

RUČICA S

Promer za bušenje	Σ dužina	Obrada (Šifra)		
		Siva	Hrom	Bela
128	135	7119	7186	7420
160	167	7120	7187	7421
192	199	7121	7188	7422
224	231	7122	7189	7423
320	327	7123	7192	7425
480	487	7351	7828	

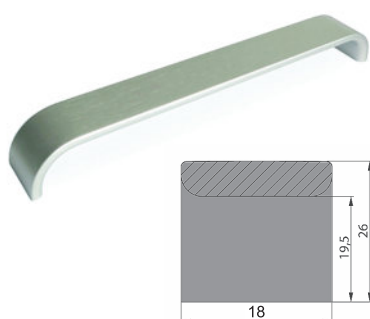
RUČICA S-18

Promer za bušenje	Σ dužina	Obrada (Šifra)		
		Siva	Hrom	Bela
128	135	7135	7213	7431
160	167	7136	7214	7432
192	199	7137	7215	7433
224	231	7138	7216	7434
320	327	7123	7217	7801

Ručica S-500



Promer za bušenje	Σ dužina	Visina / Širina	Obrada (Šifra)			
			Siva	Bela	Crna	Hrom
160	167	30/33	4132	4240	4244	4373
224	231	30/33	4133	4241	4245	4374
320	327	30/33	4131	4242	4246	4375

RUČICA TU-22

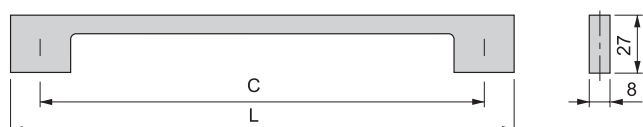
C	L	Obrada (Šifra)			
		Siva	Bela	Crna	Hrom
160	180	7875	7895	7905	7922
192	212	7876	7896	7906	7923T
224	244	7877	7897	7907	7924
320	340	7880	7900	7910	7927
480	500	7918	7919	7921T	7931

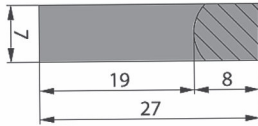

RUČICA P-26



Promer za bušenje	Σ dužina	Obrada (Šifra)			
		Siva	Hrom	Crna	Bela
128	148	7148	7365	7737	7441
160	180	7153	7366	7738	7442
192	212	7170	7367	7739	7443
224	244	7171	7368	7740	7444
256	276	7172	7369	7741	7445
320	340	7174	7371	7743	7447

RUČICA L

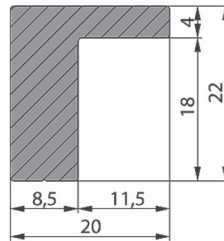

Promer za bušenje	Σ dužina	Obrada (Šifra)
		Siva
064	084	M13.7114
096	126	M13.7115
128	168	M13.7116
160	200	M13.7102
192	244	M13.7101
224	264	M13.7103
320	360	M13.7104
512	552	M13.7105

L DUGME

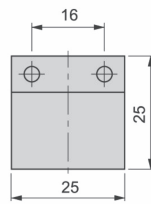
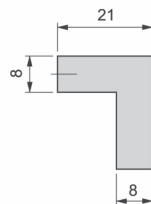

Promer za bušenje	Obrada (Šifra)
	Siva
Dugme	M13.7113

RUČICA UGAONA

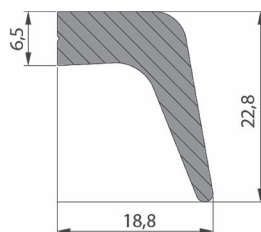

Promer za bušenje	Σ dužina	Obrada (Šifra)	
		Siva	Bela
064	084	7106	7407
096	116	7107	7408
128	148	7108	7409
160	200	7109	7410
192	212	7110	7411
224	244	7111	7412
320	340	7112	7415
416	436	7387	7417
480	500	7388	7418
512	532	7118	7419

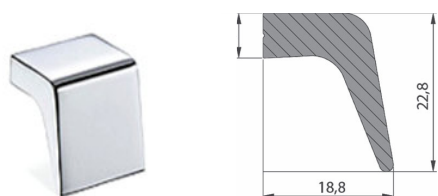
UGAONO DUGME

Promer za bušenje	Obrada (Šifra)
	Siva
Dugme	7117

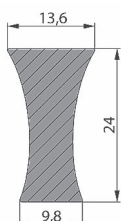
RUČICA SU-35

Promer za bušenje	Σ dužina	Obrada (Šifra)
		Siva
096	114	7475
128	146	7463-SU
160	178	7464
192	210	7465
224	242	7466
320	338	7469

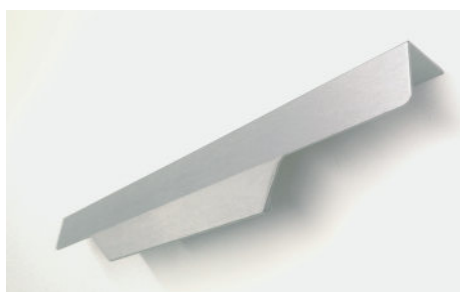
RUČICA SU-27

Σ dužina	Obrada (Šifra)		
	Siva	Bela	Crna
150	4140	4251	4263
200	4141	4252	4264
250	4142	4253	4265
300	4143	4254	4266
450	4146	4257	4269
600	4147	4259	4271

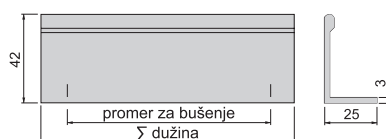
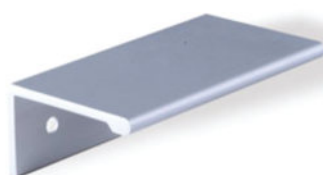
RUČICA MONACO

Promer za bušenje	Σ dužina	Obrada (Šifra)
		Siva
100	140	9302862

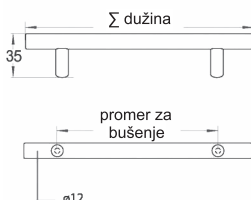
RUČICA FI-12

Promer za bušenje	Σ dužina	Obrada (Šifra)	
		Siva	Hrom
128	178	7124	7129
160	210	7125	7130
192	242	7126	7131
224	274	7127	7132
320	370	7128	7133
480	530	7333	7336
672	722	7449	7337

RUČICA 040A

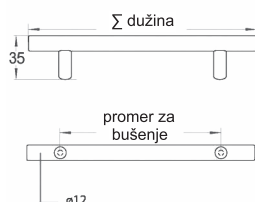

Promer za bušenje	Σ dužina	Obrada (Šifra)
		Inox
128	188	18.040A.128.01
160	208	18.040A.160.01
192	252	18.040A.192.01
224	284	18.040A.224.01
256	336	18.040A.256.01
320	408	18.040A.320.01
480	560	18.040A.480.01
672	752	18.040A.672.01

RUČICA TRIEST

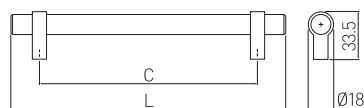

Promer za bušenje	Σ dužina	Obrada (Šifra)
		Inox
128	168	RS-TRIES-128-06
160	200	RS-TRIES-160-06
192	232	RS-TRIES-192-06
320	360	RS-TRIES-320-06

RUČICA E75

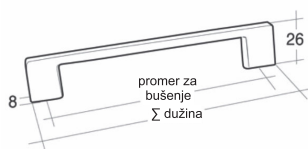

Promer za bušenje	Σ dužina	Obrada (Šifra)		
		Siva	Hrom	Nikl Saten
128	154	18.E75.128.09	18.E75.128.10	18.E75.128.22
160	192	18.E75.160.09	18.E75.160.10	18.E75.160.22
192	222	18.E75.192.09	18.E75.192.10	18.E75.192.22
224	255	18.E75.224.09	18.E75.224.10	18.E75.224.22

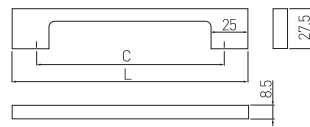

RUČICA UZ-819

Promer za bušenje	Σ dužina	Obrada (Šifra)			
		Crna/Bakar	Bakar	Srebro	Crni Hrom
128	161	UZ-819128-14	UZ-819128-15	UZ-819128-07	UZ-819128-12
160	193	UZ-819160-14	UZ-819160-15	UZ-819160-07	UZ-819160-12
192	225	UZ-819192-14	UZ-819192-15	UZ-819192-07	UZ-819192-12
320	353	UZ-819320-14	UZ-819320-15	UZ-819320-07	UZ-819320-12

RUČICA S-300



Promer za bušenje	Σ dužina	Obrada (Šifra)	
		Siva	Hrom
128	154	7451	7750
160	186	7452	7751
192	218	7453	7752
224	250	7454	7753-S
320	346	7457	7756

RUČICA S-400

Promer za bušenje	Σ dužina	Obrada (Šifra)			
		Siva	Bela	Crna	Hrom
128	136	7528	7814	7816	7530
160	168	7529	7815	7817	7531

RUČICA UZ-133

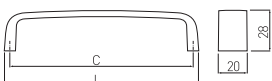
Promer za bušenje	Σ dužina	Obrada (Šifra)	
		Hrom	Nikl Saten
128	135	UZ-133128-01	UZ-133128-02



RUČICA SU-37



Promer za bušenje	Σ dužina	Obrada (Šifra)			
		Siva	Crna	Šampanj	Bela
160	195	7842	7848	7844	7846
192	230	7843	7849	7845	7847

RUČICA TU-160



Promer za bušenje	Σ dužina	Obrada (Šifra)			
		Siva	Bela	Crna	Hrom
192	212	4129	4349	4351	4100
224	244	4130	4350	4352	4101

RUČICA MI-35



Promer za bušenje	Σ dužina	Obrada (Šifra)			
		Siva	Bela	Crna	Hrom
192	212	4355	4357	4359	4365
224	244	4356	4358	4360	4366

RUČICA KOBE

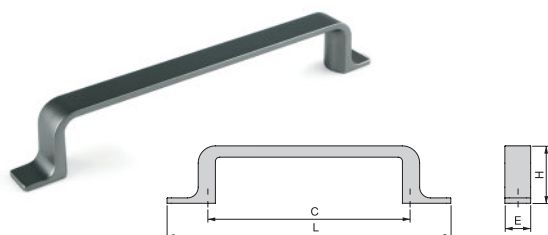

Promer za bušenje	Σ dužina	H	E	Obrada (Šifra)
				Titanium
096	110	26,7	14	9356052
128	142	29,2	15,4	9356152
160	174	30,5	16,5	9356252

RUČICA KYOTO

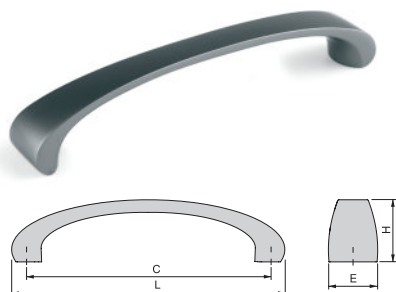

Promer za bušenje	Σ dužina	H	E	Obrada (Šifra)
				Titanium
096	110	25,5	20	9355752
128	142	25,5	21	9355852
160	174	25,5	22,5	9355952

RUČICA NAGOYA

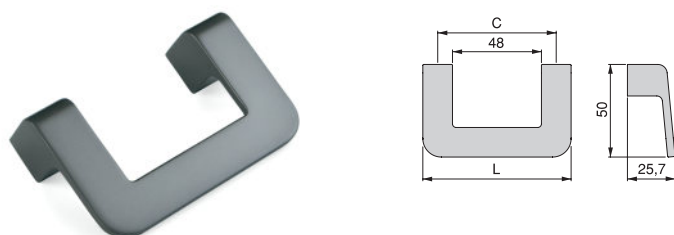

Promer za bušenje	Σ dužina	Obrada (Šifra)
		Titanium
064	080	9355652

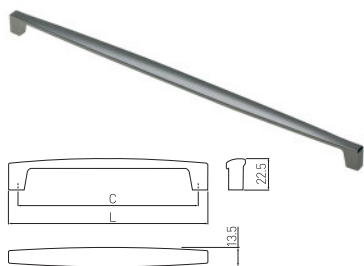
RUČICA TIVOLI

Promer za bušenje	Σ dužina	Obrada (Šifra)		
		Hrom	Crna hrom	Titanium
192	206	UZ-TIVOL-192-01	UZ-TIVOL-192-12	UZ-TIVOL-192-13
320	334	UZ-TIVOL-320-01	UZ-TIVOL-320-12	UZ-TIVOL-320-13

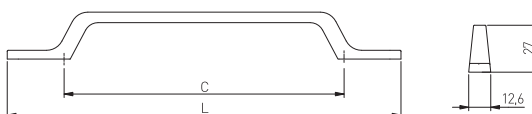
RUČICA FLAVIO

Promer za bušenje	Σ dužina	Obrada (Šifra)			
		Hrom	Inox	Brušeno zlato	Crna mat
128	193	UZ-FLAVIO-128-01	UZ-FLAVIO-128-06	UZ-FLAVIO-128-16	UZ-FLAVIO-128-20
160	225	UZ-FLAVIO-160-01	UZ-FLAVIO-160-06	UZ-FLAVIO-160-16	UZ-FLAVIO-160-20

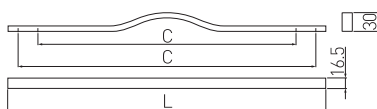
RUČICA DOPPIO

Promer za bušenje	Σ dužina	Obrada (Šifra)	
		Hrom	
192/224	256	UA-DOPPIO192-01	
416/480	512	UA-DOPPIO416-01	

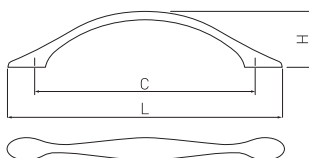
RUČICA CAMAIO

Promer za bušenje	Σ dužina	H	Obrada (Šifra)				
			Hrom	Nikl Saten	Inox	Crna hrom	Crna mat
096	128	23	CAMAI-96-01	CAMAI-96-02	CAMAI-96-06	CAMAI-96-12	CAMAI-96-20
128	160	32,5	CAMAI-128-01	CAMAI-128-02	CAMAI-128-06	CAMAI-128-12	CAMAI-128-20



RUČICA 82



Promer za bušenje	Obrada (Šifra)
	Rustik orb
096	9-31656
128	9-31657
160	9-31658

DUGME 82



Promer za bušenje	Obrada (Šifra)
	Rustik orb
Dugme	9-31655

RUČICA S020



Promer za bušenje	Obrada (Šifra)
	Crna
096	9-31651
128	9-31652

DUGME S020



Promer za bušenje	Obrada (Šifra)
	Crna
Dugme	9-31650

RUČICA 10046



Promer za bušenje	Obrada (Šifra)
	Rustik alu
096	9-31668

DUGME 10046



Promer za bušenje	Obrada (Šifra)
	Rustik alu
Dugme	9-31667

RUČICE PALERMO

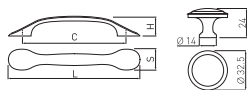

Promer za bušenje	Σ dužina	H	E	Obrada (Šifra)
				Silver
096	127	22,5	23	UZ-PALER-96-07

DUGME PALERMO

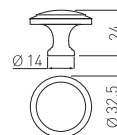

Promer za bušenje	Obrada (Šifra)
	Silver
Dugme	GZ-PALER-1-07

RUČICA OLBIA

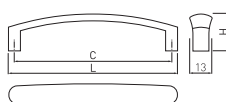

Promer za bušenje	Σ dužina	H	Obrada (Šifra)
			Mesing
096	103	22	UZ-OLBIA-96-04

DUGME OLBIA

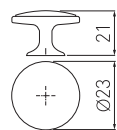

Promer za bušenje	Obrada (Šifra)
	Mesing
Dugme	GZ-OLBIA-1-04

RUČICA 61221



Promer za bušenje	Obrada (Šifra)
	Rustik alu
128	9-31648

RUČICA A23601



Promer za bušenje	Obrada (Šifra)
	Rustik alu
096	9-31649

RUČICA A208022

Promer za bušenje	Obrada (Šifra)
	Rustik Silver
096	9-31653
128	9-31654

RUČICA 8057

Promer za bušenje	Obrada (Šifra)
	Rustik br
096	9-92871

RUČICA 5423



Promer za bušenje	Obrada (Šifra)
	Antik
128	9-24046

DUGME 5423

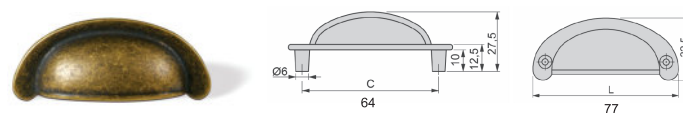

Promer za bušenje	Obrada (Šifra)
	Antik
Dugme	9-24045

RUČICA 87

Promer za bušenje	Obrada (Šifra)		
	Hrom	Inox	Antik Orb
76	9-31662	9-31664	9-31665

RUČICA MARRAKECH

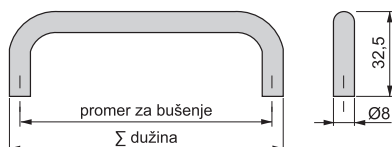
Naziv artikla	Šifra
RUČICA MARRAKECH	9348908

RUČICA COIMBRA

Promer za bušenje	Σ dužina	Obrada (Šifra)
		Hrom
096	104	9298811
128	136	9298911

RUČICA 011

Promer za bušenje	Σ dužina	Obrada (Šifra)		
		Siva	Hrom	Nikl Saten
096	136	18.011.096.09	18.011.096.10	18.011.096.22
128	186	18.011.128.09	18.011.128.10	18.011.128.22

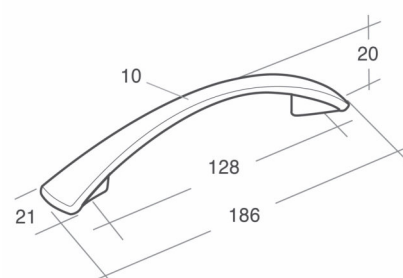
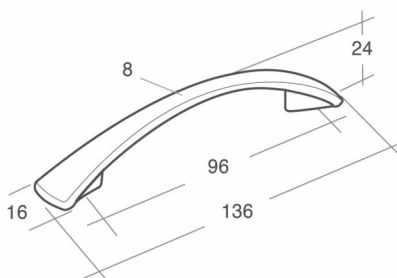

RUČICA E01

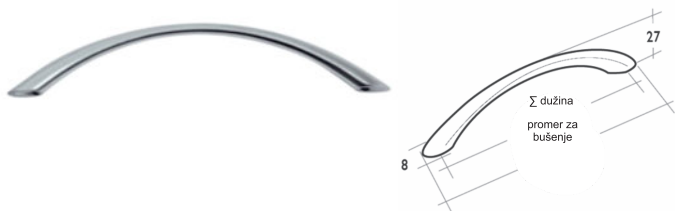

Promer za bušenje	Σ dužina	Obrada (Šifra)	
		Siva	Hrom
064	075	18.E01.064.09	18.E01.064.10
096	111	18.E01.096.09	18.E01.096.10
128	148	18.E01.128.09	18.E01.128.10

DUGME PANAMA

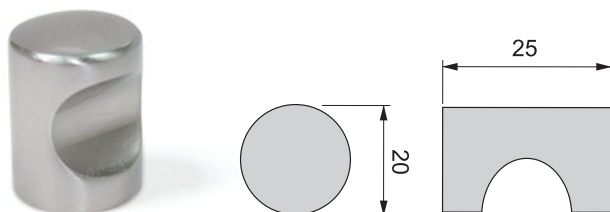

Promer za bušenje	Obrada (Šifra)
	Niki Saten
Dugme	9291951

DUGME TERNI

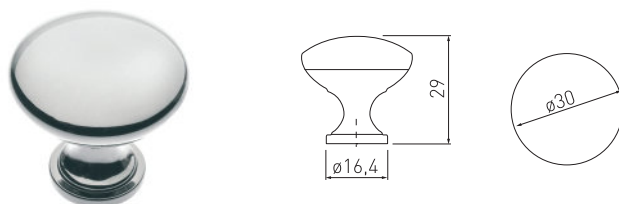

Promer za bušenje	Obrada (Šifra)					
	Hrom	Niki Saten	Siva	Crna hrom	Bela	Crna
Dugme	GZ-TERNI-1-01	GZ-TERNI-1-02	GZ-TERNI-1-05	GZ-TERNI-1-12	GZ-TERNI-1-10	GZ-TERNI-1-20M

DUGME CENTO

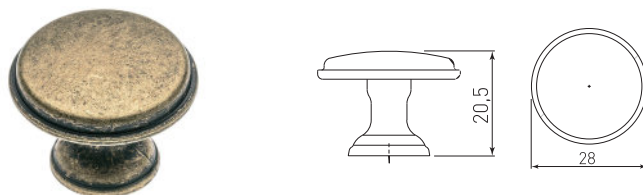

Promer za bušenje	Obrada (Šifra)			
	Mesing	Silver	Bakar	Crna
Dugme	GZ-CENTO-1-04	GZ-CENTO-1-07	GZ-CENTO-1-14	GZ-CENTO-1-20M

TUSCON

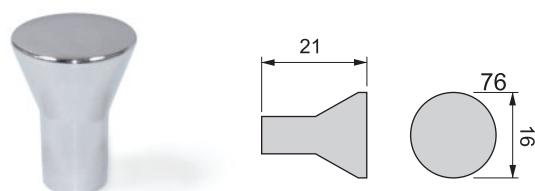

Promer za bušenje	Obrada (Šifra)		
	Siva	Hrom	Niki Saten
Dugme	9292064	9292011	9292051

PROFILI
RUČICA RHODES

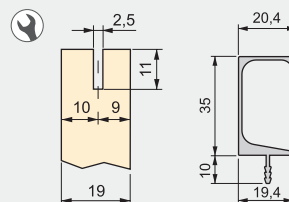
 Planiranje

Naziv artikla

RUČICA RHODES L-3M

Šifra

9296662

RUČICA MONAKO

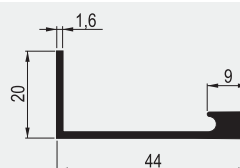
 Planiranje

Naziv artikla

RUČICA MONAKO L-3M

Šifra

2-554

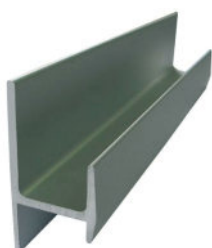
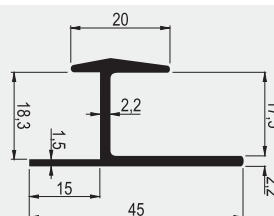
RUČICA SETUBAL

 Planiranje

Naziv artikla

RUČICA SETUBAL L-3M

Šifra

2-1013



UKOPAVAJUĆE

BOLONJA

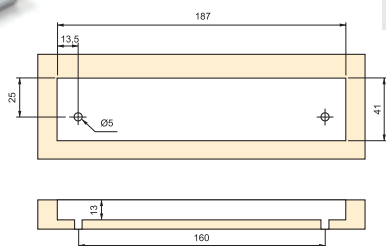

C	L	Obrada (Šifra)	
		Siva	
160	190	9292262	

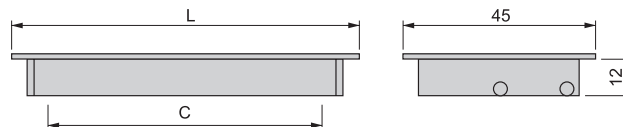

MODENA

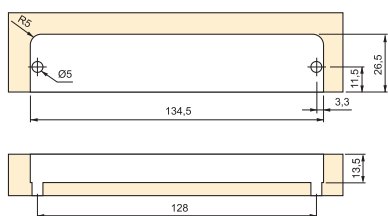

C	L	Obrada (Šifra)	
		Siva	
128	137	9291525	

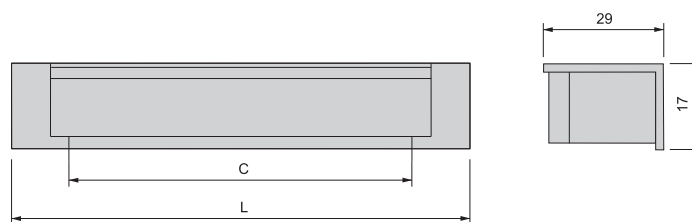

SIENA

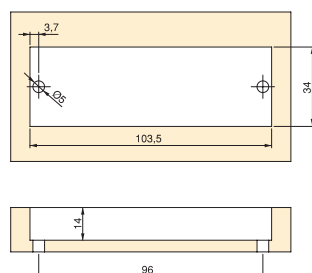

C	L	Obrada (Šifra)	
		Siva	Nikla saten
096	107	9356364	9356351

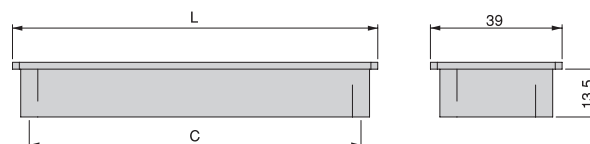

PARMA

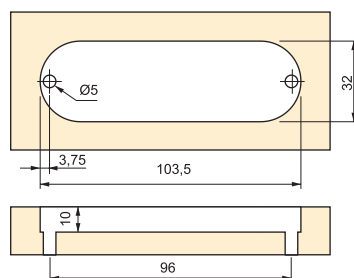

C	L	Obrada (Šifra)	
		Siva	Hrom
096	107	9291664	9291611

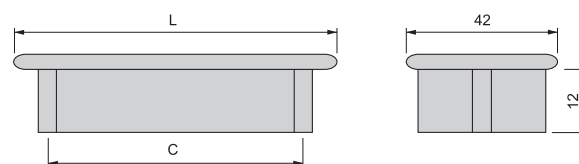

OREGON

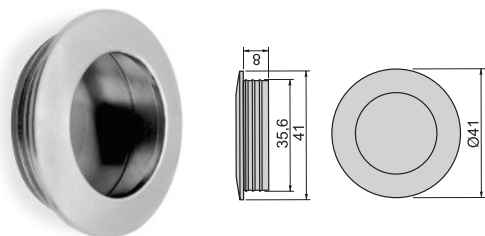

Promer za bušenje	Obrada (Šifra)		
	Siva	Nikl Saten	Moka
L-35	9298562	9298551	9298513

B226



Promer za bušenje	Obrada (Šifra)		
	Hrom	Nikl Saten	Siva
L-40	UZ-00B226-01	UZ-00B226-02	UZ-00B226-05



KUKE

TOLEDO A0

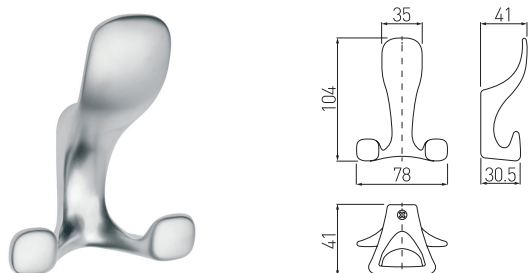

Obrada	Hrom	Nikl Saten	Siva	Inox	Crna
Šifra	WZ-TOLED-A0-01	WZ-TOLED-A0-02	WZ-TOLED-A0-05	WZ-TOLED-A0-06	WZ-TOLED-A0-20M

TOLEDO C0

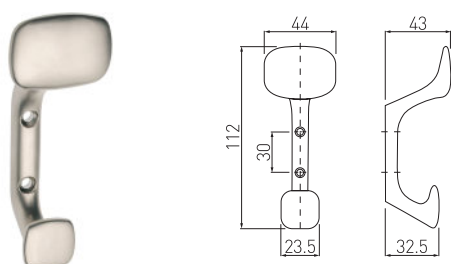

Obrada	Hrom	Nikl Saten	Siva	Inox	Crna
Šifra	WZ-TOLED-C0-01	WZ-TOLED-C0-02	WZ-TOLED-C0-05	WZ-TOLED-C0-06	WZ-TOLED-C0-20M

VALENSIJA

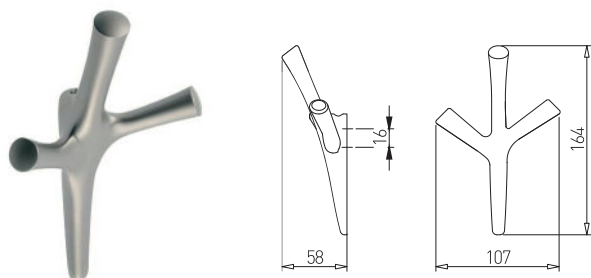

Obrada	Hrom	Inox	Crna
Šifra	WZ-WALENCIA-01	WZ-WALENCIA-06	WZ-WALENCIA-20M

CORDOBA

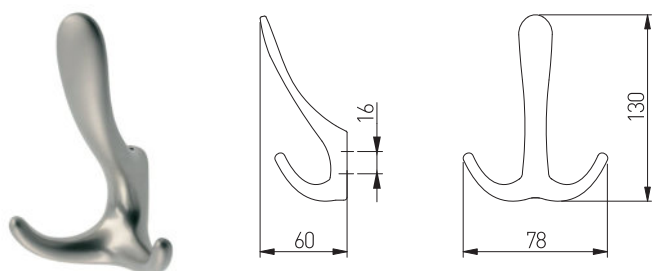

Obrada	Hrom	Inox	Crna
Šifra	WZ-CORDOBA-01	WZ-CORDOBA-06	WZ-CORDOBA-20M

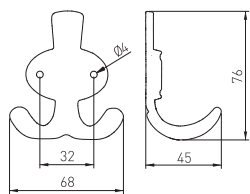
CORUNA M

Obrada	Mesing	Silver	Crna
Šifra	WZ-CORUNA-M-04	WZ-CORUNA-M-07	WZ-CORUNA-M-20M

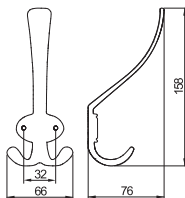
CORUNA D

Obrada	Mesing	Silver	Crna
Šifra	WZ-CORUNA-D-04	WZ-CORUNA-D-07	WZ-CORUNA-D-20M

MADRID

Obrada	Mesing	Silver	Bronze	Crna
Šifra	WZ-MADRYT-04	WZ-MADRYT-07	WZ-MADRYT-15	WZ-MADRYT-20M

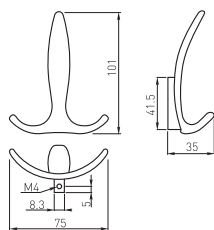
E18

Obrada	Hrom	Nikl Saten	Siva	Inox
Šifra	WZ-E-018-01	WZ-E-018-02	WZ-E-018-05	WZ-E-018-06

KUKA C-1

Obrada	Siva	Bela	Crna	Antracit
Šifra	4367	4368	4369	4370

KUKA M-1



Obrada	Siva-Hrom	Bela-Hrom	Crna-Hrom	Bela
Šifra	8113	8138	8139	8118

KUKA LEO



Obrada	Hrom	Inox	Siva
Šifra	9-15866	9-15865	9-15863

KUKA LEO S



Obrada	Hrom	Inox	Siva
Šifra	9-15875	9-15869	9-15868

KUKA 889V



Obrada	ORB
Šifra	9-31660

KUKA 889M

Obrada	ORB
Šifra	9-31659

KUKA 89

Obrada	ORB
Šifra	9-31661

KUKA M

Naziv artikla	Šifra
KUKA MANJA SIVA-M	4135

KUKA ML

Naziv artikla	Šifra
KUKA VEĆA SIVA-ML	100-0082

