

DIALOGO 360 WORKSTATION

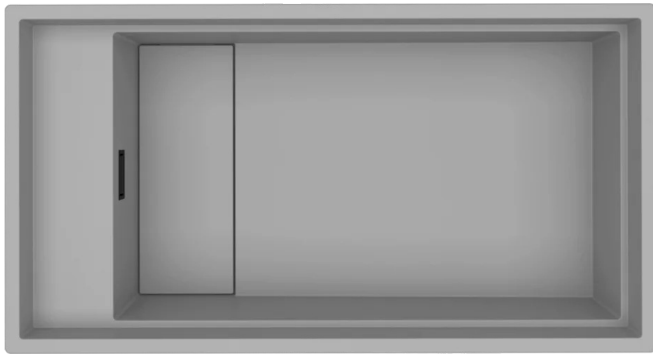

Technical Drawing

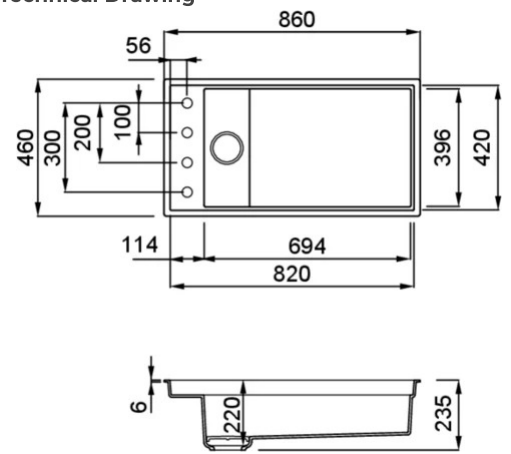

0

Description	1-bowl sink
Model	DIALOGO 360 WORKSTATION
Base (mm)	900
0	Inset Undermount
Dimensions (mm)	860 x 460
Hole for built-in installation (mm)	850 x 450 R5 (Inset), 820 x 420 R4 (Undermount)
Bowl Depth (mm)	220

900

0

Gross Weight (kg)	14,60
Net Weight (kg)	10,20
Packaging Dimension (kg)	940 x 575 x 300

0

Packaging	Cardboard and polyethylene
------------------	----------------------------

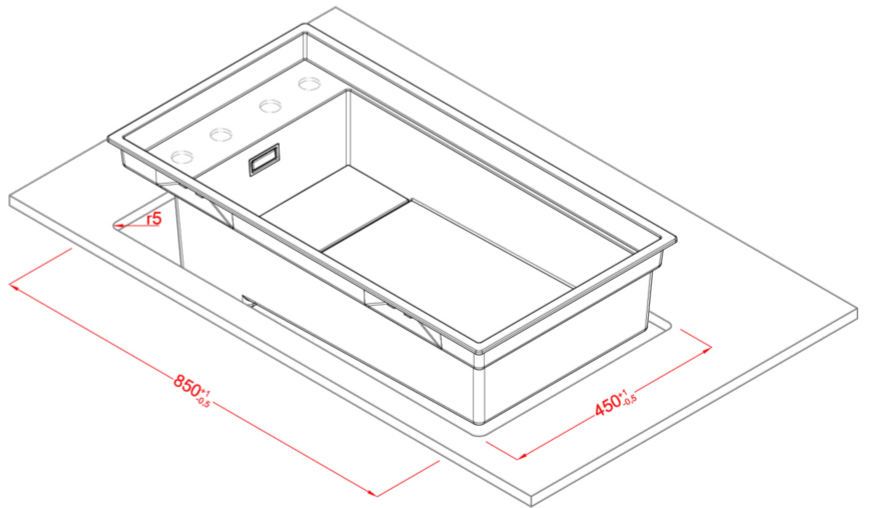
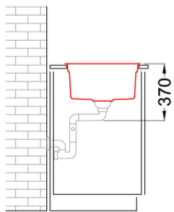
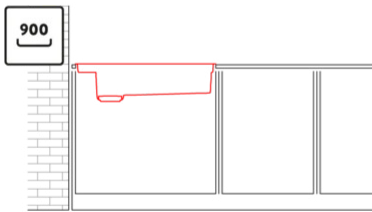
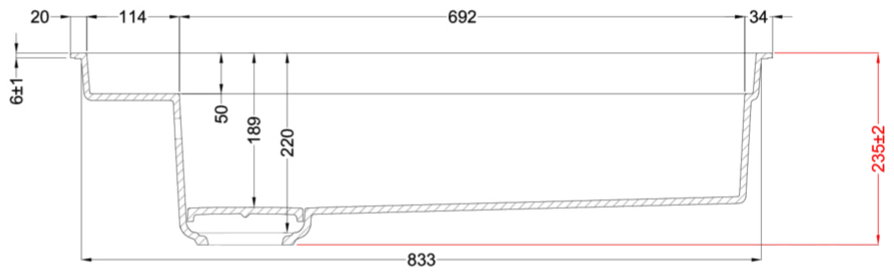
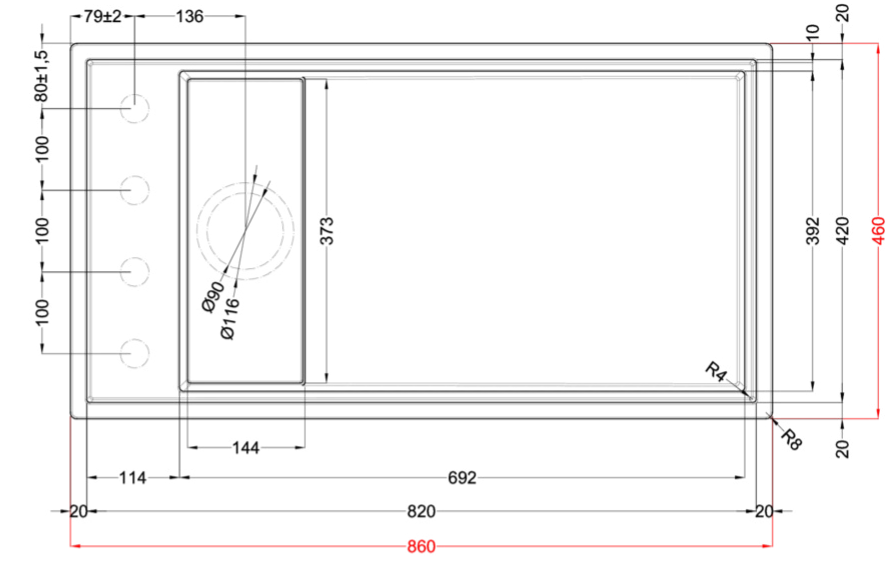
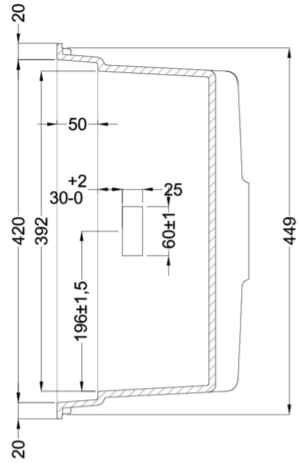

DIALOGO 360

general tolerances where not expressly communicated ±0.2%
connection dimensions according to UNI EN 695



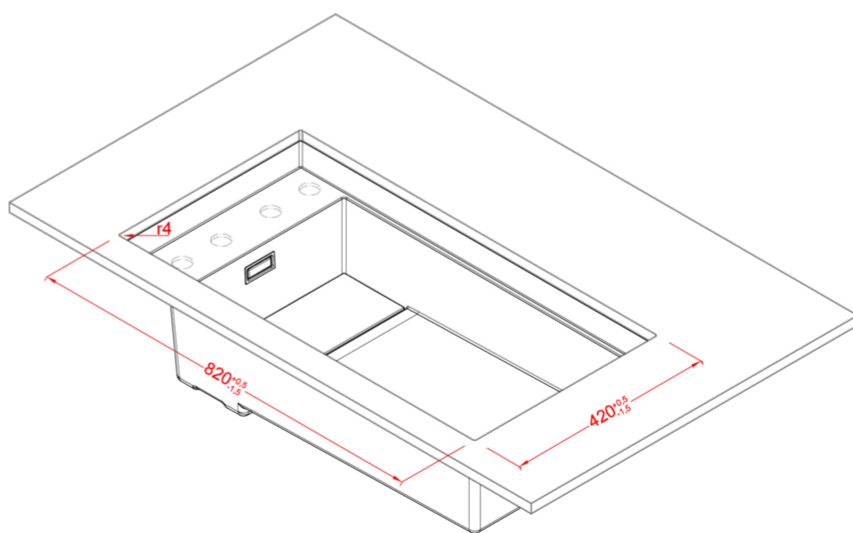
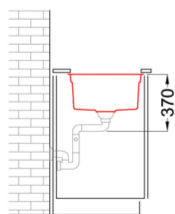
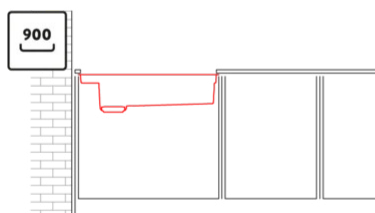
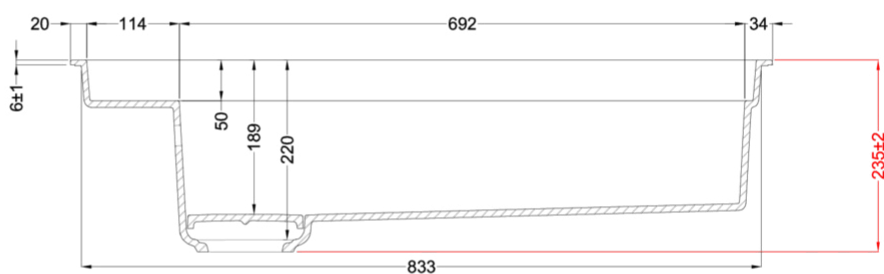
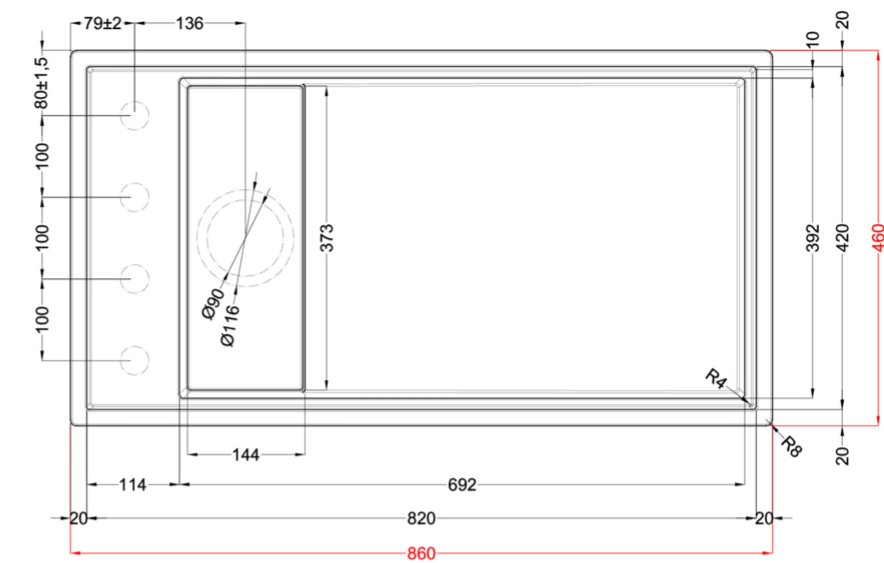
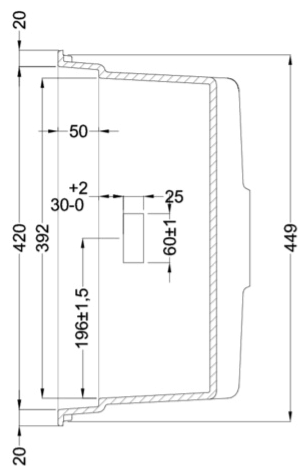

DIALOGO 360 UNDERMOUNT

general tolerances where not expressly communicated $\pm 0.2\%$
 connection dimensions according to UNI EN 695

